



Avance 3D / Triple Resonance

Introduction to

3-dimensional and triple resonance
NMR-spectroscopy
with focus on biomolecules
on Avance spectrometers

The information in this course may be altered without notice.
BRUKER accepts no responsibility for actions taken as a result

of use of this course. BRUKER accepts no liability for any mistakes contained in the course, leading to coincidental damage, whether during installation or operation of the instrument.

Unauthorised reproduction of course contents, without written permission from the publishers, or translation into another language, either in full or in part, is forbidden.

This course manual was written
And desktop published by

Helena Kovacs (Application)

© March 1, 2003, Bruker AG
Fällanden, Switzerland
P/N Z31525
DWG-No. 1232001

INDEX

INTRODUCTION	1
7	
Goals of the course 1.1	7
From 2D to 3D 1.2	8
The basic principle.....	8
Acquisition parameter display	9
Processing parameter display.....	11
Manual set-up with standard parameter sets 1.3	12
Automated set-up by using IconNMR 1.4	12
Choice of the pulse sequence 1.5	15
Strategies for protein NMR studies 1.6	17
Biomolecular sample preparation 1.7	20
PULSE CALIBRATION	2
21	
RF routing 2.1	21
¹H observe pulse 2.2	22
¹³C inverse mode 2.3	22
¹⁵N inverse mode 2.4	22
¹³C selective excitation/inversion, inverse mode 2.5	22
PROSOL Table of pulse lengths and power levels 2.6	25
²H decoupling pulse 2.7	26
Delays 2.8	27
Summary of the calibrated pulse lengths 2.9	28
Preparatory 1D and 2D experiments 2.10	29
¹H-¹³C TOCSY-HSQC	3
31	
Introduction 3.1	31
Pulse Sequence Diagram 3.2	32
Data Acquisition 3.3	33
Setting up the experiment.....	33
Recording the two 2D planes 3.4	35

Inspection of 2D planes.....	35
Phase corrections	35
Window functions.....	36
Spectrum Processing 3.5.....	36
Processing the 3D spectrum.....	36
Additional processing parameters 3.6.....	38
Linear prediction 3.7.....	39
¹H-¹⁵N NOESY-HSQC	4
40	
Introduction 4.1.....	40
Pulse Sequence Diagram 4.2.....	41
Data Acquisition 4.3.....	42
Setting up the experiment.....	42
The „GS“ Interactive mode to optimize acquisition parameters	43
Spectrum Processing 4.4.....	44
Broadband, adiabatic and selective ¹³C decoupling 4.5.....	45
Broadband decoupling.....	45
Adiabatic decoupling.....	46
Selective decoupling.....	46
HNHA 5.....	47
Introduction 5.1.....	47
Pulse Sequence Diagram 5.2.....	48
Data Acquisition 5.3.....	49
„GS“ Interactive mode to optimize acquisition parameters.....	50
Spectrum Processing 5.4.....	50
HNCA 6.....	52
Introduction 6.1.....	52
Pulse Sequence Diagram 6.2.....	53
Data Acquisition 6.3.....	54
Adding ² H decoupling.....	56
Spectrum Processing 6.4.....	56
HN(CO)CA.....	7
58	
Introduction 7.1.....	58
Pulse Sequence Diagram 7.2.....	59

Data Acquisition	7.3	60
Creating the ¹³ C frequency list.....		62
Spectrum Processing	7.4	62
CBCA(CO)NH		8
64		
Introduction	8.1	64
Pulse Sequence Diagram	8.2	65
Data Acquisition	8.3	66
Spectrum Processing	8.4	68
HBHA(CO)NH	9	69
Introduction	9.1	69
Pulse Sequence Diagram	9.2	70
Data Acquisition	9.3	71
Spectrum Processing	9.4	73
H(CC)(CO)NH	10	74
Introduction	10.1	74
Pulse Sequence Diagram	10.2	75
Data Acquisition	10.3	76
Spectrum Processing	10.4	78
HCCH-TOCSY	11	80
Introduction	11.1	80
Pulse Sequence Diagram	11.2	81
Data Acquisition	11.3	82
Spectrum Processing	11.4	84
APPENDICES		12
86		
Coupling constants in polypeptides	12.1	86
¹³C and ¹H chemical shifts in different residues	12.2	87
Sensitivity of triple resonance experiments	12.3	89

FIGURES

Fig. 1. The 3D pulse sequence.....	8
Fig. 2. The 3D spectrum.....	9
Fig. 3. The acquisition parameter display.....	10
Fig. 4. The processing parameter display.....	11
Fig. 5. IconNMR start display.....	12
Fig. 6. 1D, 2D and double resonance 3D experiments in IconNMR ToolBox.....	13
Fig. 7. Triple resonance in IconNMR ToolBox.....	14
Fig. 8. Choice of the pulse sequence.....	16
Fig. 9. NMR-structure of a 120-residue protein.....	20
Fig. 10. RF-routing.....	21
Fig. 11. Shaped 90°- ¹³ C-pulse calibration (anti-phase signal).....	23
Fig. 12. Shaped 180°- ¹³ C-pulse calibration (in-phase signal).....	24
Fig. 13. The 90-degree hard, decoupling and mixing pulses for ¹³ C, 2nd channel.....	25
Fig. 14. The necessary soft pulses for ¹³ C through the 2nd channel.....	25
Fig. 15. Deuterium pulse calibration.....	27
Fig. 16. Coupled ¹ H 1D-spectrum of a ¹⁵ N, ¹³ C-labeled protein.....	29
Fig. 17. Folding and aliasing of the ¹³ C-dimension.....	30
Fig. 18. Example of aliasing of the ¹³ C-dimension in the ¹³ C-HSQC spectrum.....	30
Fig. 19. ¹ H- ¹³ C TOCSY-HSQC.....	32
Fig. 20. The ¹ H- ¹ H and ¹ H- ¹³ C planes of the ¹ H- ¹³ C TOCSY-HSQC spectrum.....	38
Fig. 21. ¹ H- ¹⁵ N NOESY-HSQC.....	41
Fig. 22. The ¹ H- ¹ H and ¹ H- ¹⁵ N planes of the ¹ H- ¹⁵ N NOESY-HSQC spectrum.....	46
Fig. 23. HNHA?.....	48
Fig. 24. The ¹ H- ¹ H plane of HNHA.....	51
Fig. 25. Magnetization transfer in the HNCA experiment.....	52
Fig. 26. HNCA.....	53
Fig. 27. The ¹ H- ¹³ C and ¹ H- ¹⁵ N planes of the HNCA spectrum.....	57
Fig. 28. Magnetization transfer in HN(CO)CA.....	58
Fig. 29. HN(CO)CA.....	59
Fig. 30. The ¹ H- ¹³ C and ¹ H- ¹⁵ N planes of the HN(CO)CA spectrum.....	63
Fig. 31. The magnetization transfer in CBCA(CO)NH.....	64
Fig. 32. CBCA(CO)NH.....	65
Fig. 33. The ¹ H- ¹³ C and ¹ H- ¹⁵ N planes of the CBCA(CO)NH spectrum.....	68
Fig. 34. The magnetization transfer in HBHA(CO)NH.....	69
Fig. 35. HBHA(CO)NH.....	70
Fig. 36. The ¹ H- ¹ H and ¹ H- ¹⁵ N planes of the HBHA(CO)NH spectrum.....	73
Fig. 37. The magnetization transfer in H(CC)(CO)NH.....	74
Fig. 38. H(CC)(CO)NH.....	75
Fig. 39. The ¹ H- ¹ H and ¹ H- ¹⁵ N planes of the H(CC)(CO)NH spectrum.....	79
Fig. 40. HCCH-TOCSY.....	81
Fig. 41. The ¹ H- ¹ H (I1=3) and ¹ H- ¹³ C planes of the HCCH-TOCSY spectrum.....	85
Fig. 42. One-bond and two-bond coupling constants in the polypeptide backbone.....	86
Fig. 43. The random coil ¹ H and ¹³ C chemical shifts in the natural amino acids.....	87
Fig. 44. The random coil ring ¹ H and ¹³ C chemical shifts of histidine, tyrosine, phenylalanine and tryptophan.....	88
Fig. 45. The random coil amide ¹ H and carbonyl ¹³ C chemical shifts in the natural amino acids.....	88
Fig. 46. The first increment of some triple resonance experiments.....	89

Introduction

1

Goals of the course

1.1

The present course will provide you with basic knowledge and tools in 3-dimensional NMR spectroscopy, and make you acquainted with a number of 3D-experiments. The course is designed to serve as a general introduction with focus on the implementation on your Bruker instrument. We have achieved our goal if you become confident with setting-up and optimizing the numerous 3D-experiments available in the Bruker standard pulse sequence library and also feel encouraged to embark upon modifying existing ones and writing additional pulse programs for your own specific purposes.

Although the scientific literature abounds in various 3D-experiments, we have restricted the course to a representative selection of them. The experiments are recorded on unlabeled, single-, double- and triple-labeled samples in order to highlight the particularities of the experimental set-up in different cases.

Usually when working with biomolecular samples the experimental sensitivity is of major concern. Although a multitude of experiments are available, the concentration, molecular size and special characteristics of the sample should be taken into consideration when choosing an NMR investigation protocol. It is advisable to proceed step by step, starting with the most sensitive experiments.

The topics of the present course cover the setting-up and processing of 3D experiments, triple resonance spectroscopy, calibration of the necessary pulses including pulses for selective excitation, applying broadband or adiabatic decoupling schemes and deuterium decoupling. Further, heteronuclear cross-polarization and optimization of water suppression are included, as well as the basics of Bruker pulse programming.

We wish you great pleasure and success in using 3D NMR as a tool in your research.

The application team of Bruker BioSpin Switzerland.

From 2D to 3D

1.2

The basic principle

A 3-dimensional experiment can be regarded as a combination of two 2-dimensional experiments.

Fig. 1. The 3D pulse sequence.

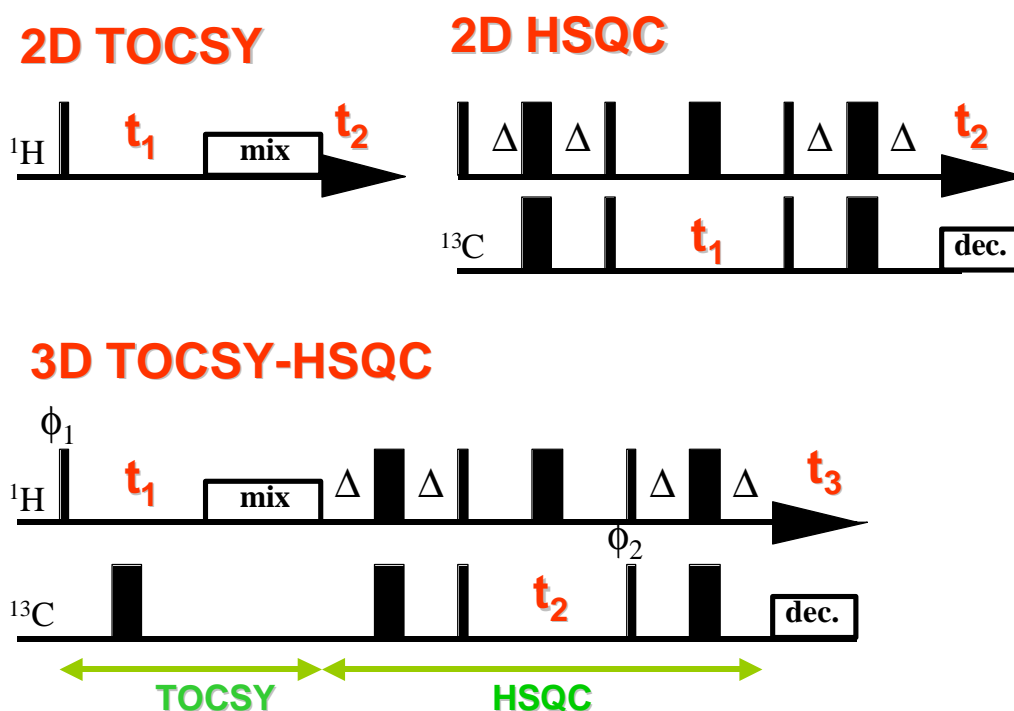

In the 3D experiments there are two evolution times that are incremented, t_1 and t_2 (the acquisition time is called t_3). During the t_1 -evolution time (following the initial 90° - ^1H pulse which creates a $-H_y$ -magnetization) the magnetization is on the proton nuclei and becomes labeled by the ^1H -chemical shift. Thereafter the TOCSY mixing of the ^1H -coherences takes place, followed by an INEPT-transfer of magnetization to the ^{13}C -nuclei. During the t_2 -evolution time, the ^{13}C -coherence, which is anti-phase with respect to the protons (in terms of the product operator H_2C_x , the ^1H -magnetization is aligned along z-axis at this point) becomes labeled by the ^{13}C -frequency. Finally the magnetization of interest is transferred back to the protons for observation during t_3 by a reverse-INEPT scheme.

Fig. 2. The 3D spectrum.

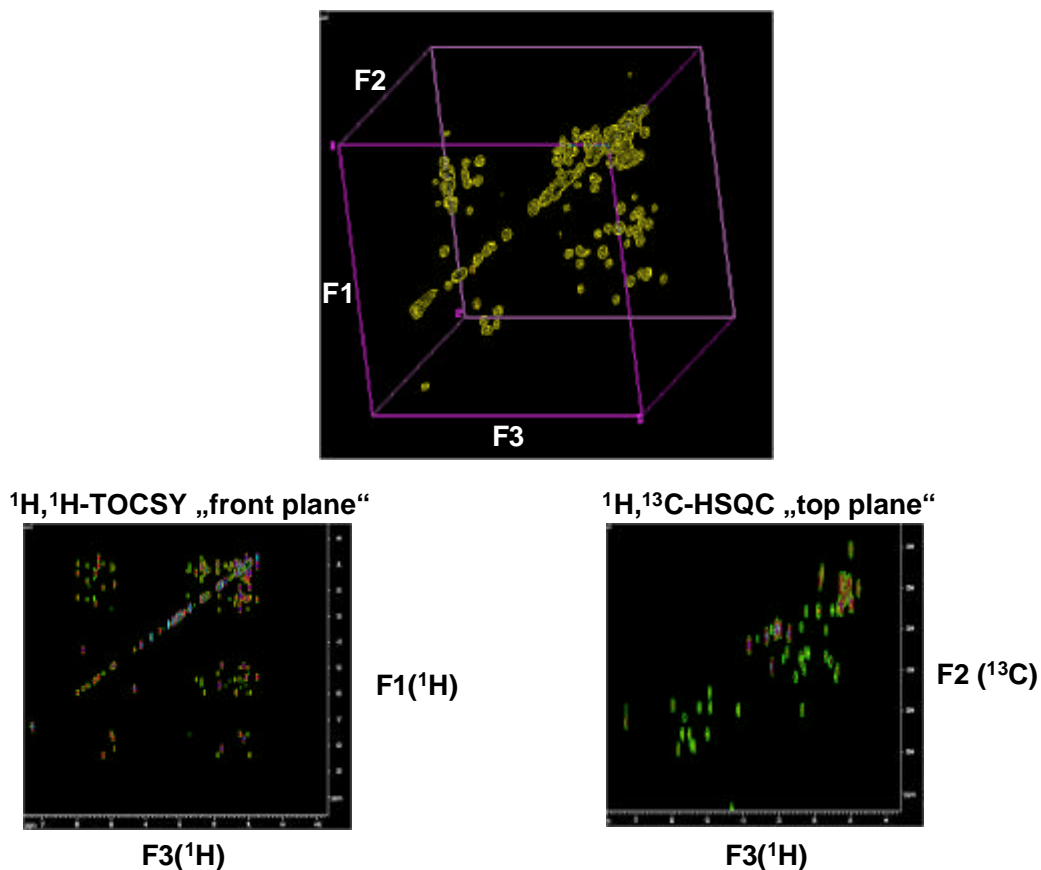

After a Fourier transform of each of the three time domains the spectrum has three frequency domains, that is, F1(^1H), F2(^{13}C) and F3(^1H).

In the F1-F3 dimension the individual planes correspond to TOCSY-spectra at a certain ^{13}C -frequency (note that only ^{13}C -bound protons give rise to signals in this spectrum). In the F2-F3 dimension the individual planes correspond to the $^1\text{H}, ^{13}\text{C}$ -HSQC-planes. You can view the individual 2D-planes in XWINNMR by using the command **display** or scan through the planes by using the **scan** option.

Acquisition parameter display

In order to set-up a 3D-experiment you need to first change **parmode** to 3D. Now the acquisition parameter display, evoked by the command **eda**, consist of three columns which correspond to the F3, F2 and F1 dimensions in this very order.

Fig. 3. The acquisition parameter display.

Parameter	F3	F2	F1	Unit
PULPROG	mlevhsqcetgp3d			
AQ_mod	DQD			
FnMODE	Echo-Antiecho		States-TPPI	
TD	1024	64	128	
PARMODE	3D			
NS	4			
DS	32			
TD0	1			
ZGOPTNS	-DLABEL_CN			
D	** Array **			sec
P	** Array **			usec
ND0			2	
IN0			0.00005951	sec
ND10		2		
IN10		0.00004360		sec
SW	13.9790	76.0000	14.0000	ppm

NUCLEI: 1H 13C 1H

You need to enter the nuclei, their sweep widths, offsets and the number of points in each dimension. The increments, d0 in F1 and d10 in F2, respectively, are deduced automatically.

Appropriate modes for the incrementation in the two indirect dimensions are entered through the parameter Fn_Mode. In addition, there is a parameter for each indirect dimension, called nd0 in F1 and nd10 in F2, that you need to set. This parameter indicates the number of times each increment (d0 and d10, respectively) actually occurs in the pulse program. In the above example, the value of nd10 is 2, because each evolution time is split into two parts by a 180°-refocusing pulse on the other nucleus. There is one exception, however; the TPPI-mode would require doubling of the nd-parameter value. For the Bruker standard pulse sequences the appropriate Fn_Mode and nd-values can be found at the end of the pulse programs.

Processing parameter display

Fig. 4. The processing parameter display.

Parameter	F3	F2	F1	Unit
SI	2048	128	512	
PPARMOD	3D			
SF	600.1300000	150.9028090	600.1300000	MHz
OFFSET	11.750	70.249	10.594	ppm
SR	0.00	0.00	0.00	Hz
HZpPT	5.261852	84.186424	8.418642	Hz
MC2		echo-antiecho	States-TPPI	
AQORDER	3-2-1			
WDW	QSINE	QSINE	QSINE	
SSB	2	2	2	
LB	1.00	0.30	0.00	Hz
GB	0.1	0.1	0	
PH_mod	pk	pk	pk	
PKNL	TRUE			
PHC0	0.000	0.000	0.000	degrees
PHC1	0.000	0.000	0.000	degrees

SAVE Parameter Next CANCEL

NUCLEI: 1H 13C 1H

The command **edp** evokes a display processing parameters in XWIN-NMR. These are discussed in detail in Chapter 3 (processing of the ^1H , ^{13}C -TOCSY-HSQC experiment). The order of the dimensions is the same as for the acquisition parameters.

Manual set-up with standard parameter sets

1.3

XWIN-NMR contains an ever increasing number of ready parameter sets for various 3D experiments. You can simply load the standard settings by typing the command **rpar *** and selecting the appropriate experiment. However, you need to enter the pulse lengths and power levels that are appropriate for the particular probe you are using. This is conveniently done by entering the **getprosol** (or short for it **gpro**) command, provided that the so called PROSOL table is up to date (see Chapter 2.6 for a detailed description).

Check the number of scans, increments and sweep widths in the **eda** display. The RF-routing is displayed by the **edsp** command. In order to inspect the active parameters only, use the command **ased**. Bruker pulse programs contain information about the meaning and appropriate setting of each parameter. Use the **edcpul** command to view the pulse program in a texteditor mode. For a schematic display of the pulse sequence type **ppg**.

Following is a summary of the manual set-up:

1. **record & optimize 1D spectrum** - determine proton 90° pulse
2. **rpar *** - select appropriate parameter set (standard or your own)
3. **gpro (= getprosol)** - pulse lengths & power levels from the PROSOL table
4. **edasp, eda, ased** - set *sw, o1p, pl1, p1* according to the 1D spectrum
- check the parameter settings
5. **multizg** - start a series of consecutive experiments

Automated set-up by using IconNMR

1.4

An alternative way of setting up 3D triple resonance experiments is to employ the biomolecular options available in **IconNMR Toolbox** which is included in XWIN-NMR Version 3.5 and later.

Fig. 5. IconNMR start display.



Having started the IconNMR ToolBox you first define a project. A project contains experiments for one or more samples, the latter applies when using an automated sample changer for several samples. Thereafter you define the sample(s) for this project. Later you can reload the project and sample settings and you can also transfer parameters from an previous project to a new one.

Check the offsets and sweep widths through the „**Manual Sample Setup**“ option. The selected values will be applied to all following experiments.

Now you can select experiments through „**1D/2D Biomolecular and Protein 3D**“. Figures 6 and 7 illustrate the selection of standard experiments available. The ones that are discussed in the present manual are highlighted with a yellow circle. By clicking on an experiment you create a corresponding sub directory in a data set denoted by the sample name you have given earlier. You can change certain parameters on the right of the ToolBox display, and you can also inspect the experimental set-up in XWIN-NMR by clicking the „**View Data** „, button in the lower left corner. End with the „**Submit**“ button.

Fig. 6. 1D, 2D and double resonance 3D experiments in IconNMR ToolBox.

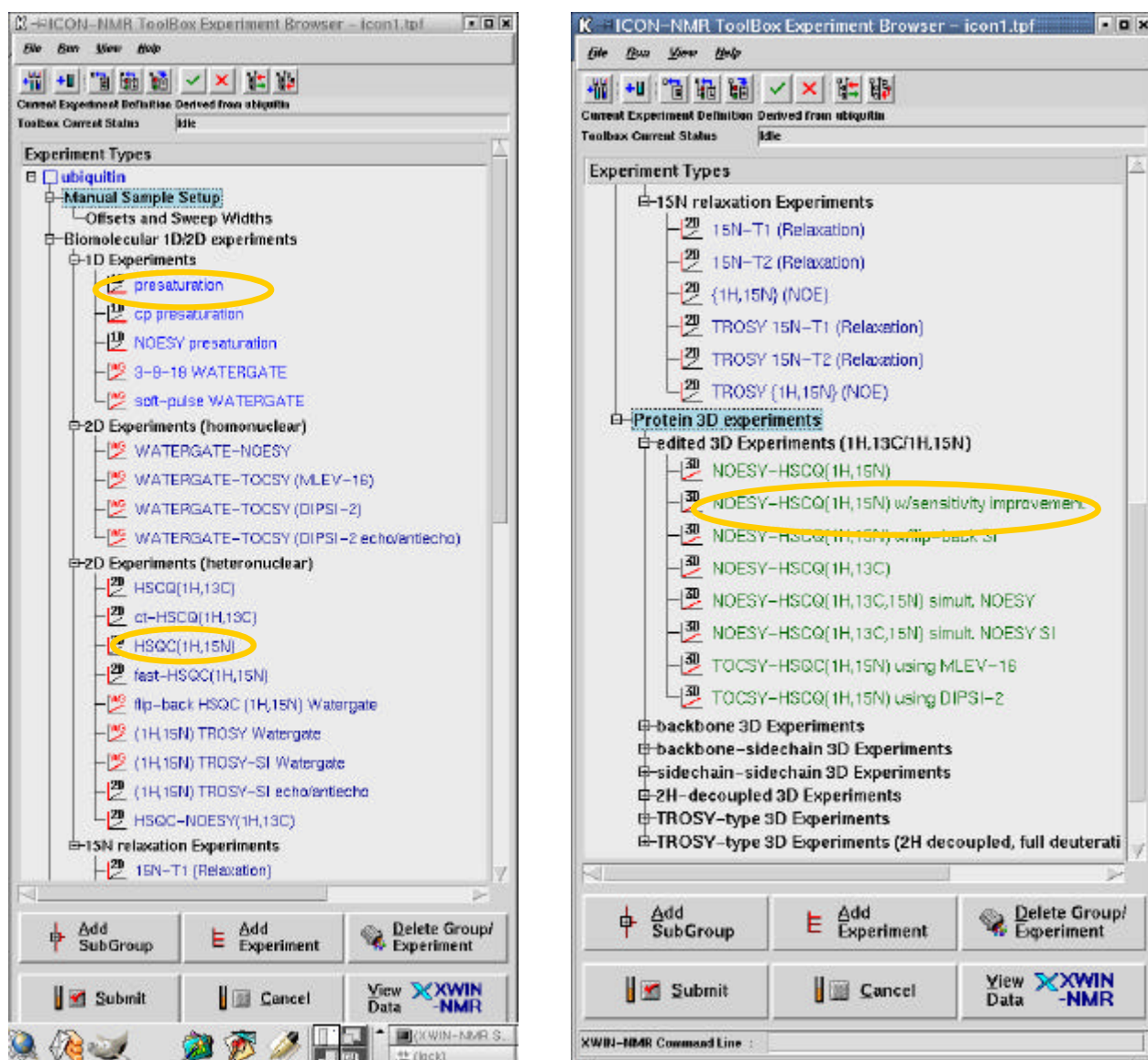

INTRODUCTION



Fig. 7. Triple resonance in IconNMR Toolbox.

Following is a summary of the automated set-up by using IconNMR ToolBox:

1. Define project

-a project contains experiments for one or more samples

2. Define sample for this project

- several samples can be defined

3. Set offsets and sweep widths in „Manual Sample Setup“

- these are applied to all following experiments

4. Select experiments in „1D/2D Biomolecular and Protein 3D“

- check the acquisition parameters

5. Submit experiment

6. GO

-start all submitted experiments

Two novel features in XWIN-NMR have enabled the automation of biomolecular NMR. First, the calibrated pulses and power levels are stored and then read, from the PROSOL Table. Second, all frequencies and sweep widths are entered in ppm, they are thus independent from the magnetic field strength.

By entering the following options in **IconNMR Configuration** operation in the single sample mode is enabled.

User Manager



User Permissions



Partition Names

⇒

d:

Master Switches



Default Automation Mode ⇒

manual

Inject/Eject



Eject last sample

⇒

no



Never Rotate sample

⇒

yes

General Options



Exp. Number Auto. Incr. ⇒

1



Password Checking ⇒

everywhere

Choice of the pulse sequence

1.5

The Bruker standard pulse program and parameter set libraries of XWIN-NMR contain most of the commonly used 3D-experiments. The diagram below shows one possible classification of these. The „double resonance“ experiments require a ¹⁵N- or ¹³C-labeled sample or an unlabeled sample at high concentration. This is essential particularly if nuclear Overhauser (NOE) type of interactions are to be monitored.

The „triple resonance“ experiments require ^{15}N - and ^{13}C -labeling. Often several improved versions of the experiments are found in literature. When different implementations are included in the Bruker standard pulse program library, they are denoted with an increasing extension, for instance, hncagp3d.1, hncagp3d.2 etc. The ^2H -decoupled versions are also included. Furthermore, XWIN-NMR provides the TROSY-implementations of the common triple resonance experiments.

Fig. 8. Choice of the pulse sequence.

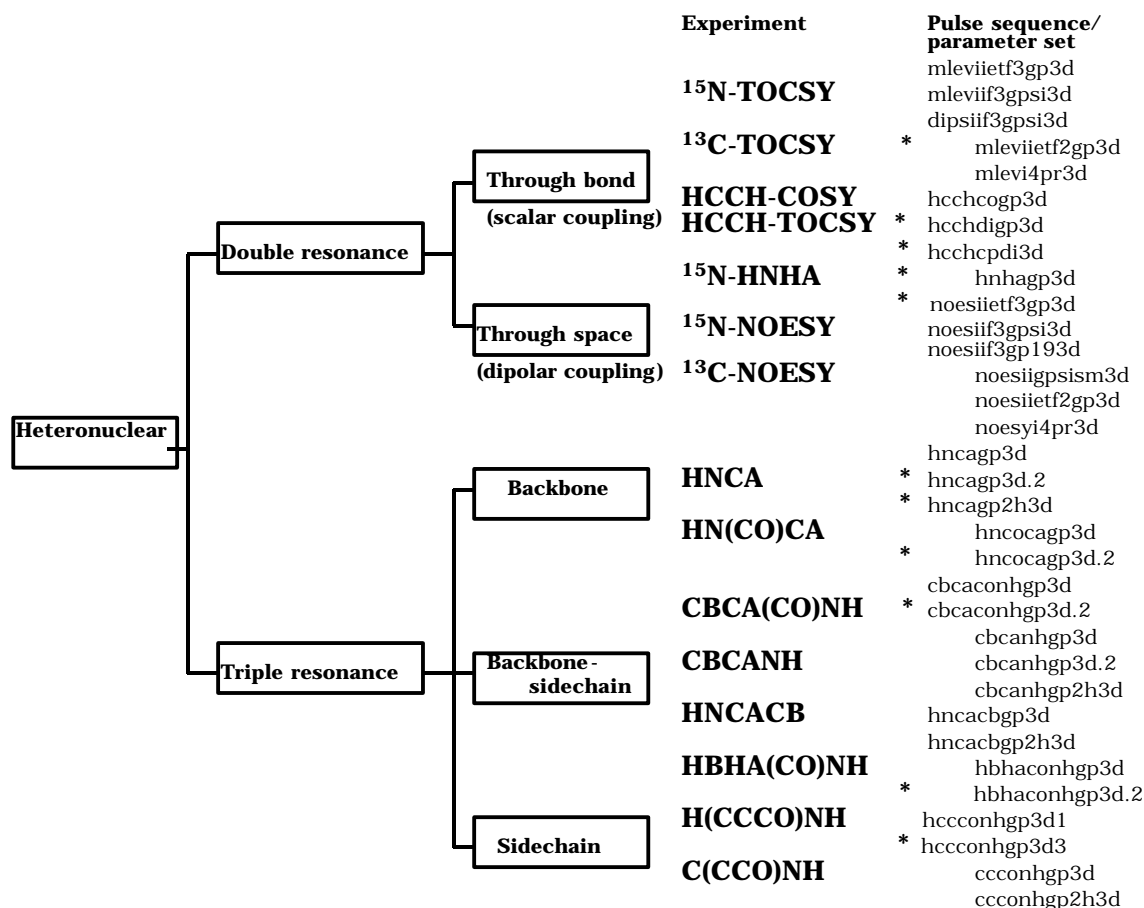

In the rightmost column of the diagram above, a selection of pulse sequences is given in order to illustrate some of the different features that have been implemented. The asterisk denotes the sequences that are used in the current 3D manual. A summary of the Bruker pulse sequence nomenclature is found on your spectrometer in the file /u/exp/stan/nmr/lists/pp/Pulprog.info. Below is a key to decipher the names in the diagram.

mlev = MLEV TOCSY mixing
pr = presaturation
ii = inverse / HSQC
et = echo-antiecho-TPPI
si = sensitivity enhanced
gp = gradient pulse syntax
f2 = heteronucleus on channel f2
2h = ^2H decoupled
tr=TROSY

dips = DIPSI-2 TOCSY mixing
19=3-9-19 WATERGATE
i4 = inverse with 4 pulses / HMQC
ea = echo-antiecho
sm = simultaneous
gs = gradient program syntax
f3 = heteronucleus on channel f3
3d = 3-dimensional
noes = NOESY

Strategies for protein NMR studies**1.6**

Table 1 proposes another classification of the common NMR experiments, now according to their applicability on different kinds of protein samples. Depending on the molecular size and the degree of labeling, a strategy is chosen in order to obtain the sequential and sidechain assignment and conformational constraints (NOEs, coupling constants and chemical shift constraints) needed for a structure elucidation. The experimental sensitivity should be considered.

For example, compare the two complementary pairs of experiments, HNCO and HN(CA)CO on one hand and HNCA and HN(CO)CA on the other. The former pair consists of a sensitive and an insensitive experiment, whereas both experiments in the latter pair are reasonably sensitive. Besides, the latter pair yields the alpha-carbon assignments which are likely to be more useful than the carbonyl-carbon assignments from the former pair. This is also why we have chosen to include the HNCA and HN(CO)CA experiments in the current manual. The pulse sequences for HNCO and HNCA are, by the way, identical except for the interchange of alpha-carbon and carbonyl frequencies. The differences in sensitivity are due to differences in the scalar coupling constants (and the corresponding delays) responsible for the magnetization transfer.

Table 1: Strategies for protein studies

Protein/Size	Experiment	Information obtained	Sensitivity
Unlabeled/ less than 50.a.a.	2D Homonuclear		
	COSY, TOCSY	intra-residue assignments	
	NOESY	sequential connectivities NOE distance constraints $^3J_{\text{HN}\alpha}$ coupling constants	
	E.COSY	$^3J_{\text{H}\alpha\beta}$ coupling constants	
^{15}N-labeled/ ~ 50-80 .a.a.	3D Double resonance		
	^{15}N -TOCSY	intra-residue assignments	
*	^{15}N -NOESY	sequential connectivities NOE constraints	
*	^{15}N -HNHA	$^3J_{\text{HN}\alpha}$ coupling constants	
	or 2D HMQC-J	$^3J_{\text{HN}\alpha}$ coupling constants	
	^{15}N -HNHB	$^3J_{\text{H}\alpha\beta}$ coupling constants	

INTRODUCTION

Protein/Size	Experiment	Information obtained	Sensitivity
^{13}C, ^{15}N-labeled/ ~ 80-150 .a.a.	3D Double resonance	NB. Possibly fractionally ^2H-labeled	
*	^{15}N -NOESY	NOE constraints	
*	^{15}N -HNHA	$^3J_{\text{HN}\alpha}$ coupling constants	
	^{15}N -HNHB	$^3J_{\text{H}\alpha\beta}$ coupling constants	
	^{13}C HCCH-COSY	intra-residue assignments	
*	^{13}C HCCH-TOCSY	intra-residue assignments	
	^{13}C NOESY	sidechain NOE constraints	
	3D Triple resonance		
	HNCO	sequential connectivity	100 inter
	HN(CA)CO	sequential connectivity (combine with HNCO)	13/4 intra/inter
*	HNCA	sequential connectivity $^{13}\text{C}^\alpha$ chemical shift constraints	50/15 intra/inter
*	HN(CO)CA	(combine with HNCA)	71 inter
*	CBCA(CO)NH	sequential connectivity $^{13}\text{C}^\alpha$ and $^{13}\text{C}^\beta$ chemical shifts	13/9 $^{13}\text{C}^\alpha / ^{13}\text{C}^\beta$ inter
	CBCANH	for smaller proteins (combine with CBCA(CO)NH)	4/1.7 $^{13}\text{C}^\alpha / ^{13}\text{C}^\beta$ intra 1.3/0.5 $^{13}\text{C}^\alpha / ^{13}\text{C}^\beta$ intra
	HNCACB	for bigger proteins (combine with CBCA(CO)NH)	
*	HBHA(CO)NH	$^1\text{H}^\alpha$ and $^1\text{H}^\beta$ assignments	13/9 $^1\text{H}^\alpha / ^1\text{H}^\beta$ inter
*	H(CCCO)NH	sidechain ^1H assignments	
	(H)CC(CO)NH	sidechain ^{13}C assignments	
^{13}C, ^{15}N, ^2H-label. >160 .a.a.	3D Triple resonance with ^2H-decoupling		
	CT-HNCA	sequential connectivity	
	HN(CO)CA	(combine with HNCA)	
	CBCA(CO)NH	sequential connectivity $^{13}\text{C}^\alpha / ^{13}\text{C}^\beta$ chemical shifts	
	CT-HNCACB	(combine with CBCA(CO)NH)	
	C(CO)NH	sidechain ^{13}C assignments	
	^{15}N -HSQC-NOESY- HSQC	sequential and long-range NH-NH NOE constraints	

The experiments presented in this manual are denoted by an asterisk.

Notes:

The sensitivity is given for both the inter- and intra-residual signals where appropriate (the experiments HNCA, HN(CA)CO) and for both the α - and β -position signals where appropriate (the experiments CBCA(CO)NH, CBCANH, HNCACB, HBHA(CO)NH).

Note that in the triple resonance experiments the signals are separated according to their backbone amide frequencies. This enables a „ ^{15}N -strip“ analysis of the spectra.

For ^{15}N , ^{13}C - and fractionally ^2H -labeled proteins 4-dimensional heteronuclear correlated NOESY techniques ($^{15}\text{N}/^{13}\text{C}$, $^{13}\text{C}/^{13}\text{C}$ or $^{15}\text{N}/^{15}\text{N}$) might become useful.

The TROSY-modifications of triple resonance experiments have been developed for large biomolecules with broad lines monitored at high magnetic fields, see Salzmänn *et al.* (1999).

Special experiments have been designed for NMR-investigations of labeled nucleic acids. More information about these is given in the references by Dieckmann & Feigon (1994) and Wijmenga & van Buuren (1998).

References:

Heteronuclear multidimensional NMR experiments for the structure determination of proteins in solution employing pulsed field gradients. M. Sattler, J. Schleucher & C. Griesinger. Prog. in NMR Spectroscopy 34 (1999) 93-158.

Determining the structures of large proteins and protein complexes by NMR. G. M. Clore & A. M. Gronenborn. TIBTECH 16 (1998) 23-24.

TROSY-type triple resonance experiments for sequential NMR assignments of large proteins. M. Salzmänn, G. Wider, K. Pervushin, H. Senn & K. Wüthrich. J. Am. Chem. Soc. 121 (1999) 844-848.

Heteronuclear techniques in NMR studies of RNA and DNA. T. Dieckmann & J. Feigon. Curr. Op. Struct. Biol. 4 (1994) 745-749.

The use of NMR methods for conformational studies of nucleic acids. S. Wijmenga & B. N. M. van Buuren. Progr. NMR Spectr. 32 (1998) 287-387.

Biomolecular sample preparation

1.7

Following points are worthy of consideration when preparing an NMR sample of a protein or a nucleic acid fragment.

- ◆ **Molecular weight** is decisive for the degree of isotope labeling and choice of NMR experiments as indicated in Table 1.
- ◆ **Volume** should be 0.5 ml with 5% D₂O. For the special Shigemi tubes 0.2 ml is sufficient.
- ◆ **Sample concentration** should be around 1 mmol for a complete structure determination. Certainly the higher the better.
- ◆ **Solvent** is preferably water. If the sample is not stable in pure water try to dissolve it in a salt buffer, for instance, 25 mmol PO₄²⁻ and 25 mmol NaCl. The buffer should not contain hydrogen atoms. The total ionic strength of the buffer should not be too high, as this leads to longer pulses.
- ◆ **pH** should be the lowest possible that still does not destabilize the native fold. Observation of exchanging amide protons is possible only up to pH ~7.5 when using optimal techniques for water suppression.
- ◆ **Temperature** should be the highest possible which still does not destabilize the native fold. Due to increased mobility at higher temperatures the NMR-signals are narrowed, which is favourable.
- ◆ **Impurities** that contain hydrogen atoms, even at concentrations of 5-10% of the macromolecular sample, will complicate the spectral analysis, particularly if they are peptides or of low molecular weight.
- ◆ **Growth of fungi** is prevented by adding a minor amount of NaN₃.
- ◆ **If reduced cysteins** are present in the polypeptide sequence, add dithiotreitol (DTT) in order to prevent aggregation through disulfide bridging. Since DTT contains protons, its concentration should maximally be similar to the protein concentration.

Fig. 9. NMR-structure of a 120-residue protein.

The structure was determined by using the experimental strategy for ¹⁵N, ¹³C-labeled proteins outlined in the current manual.

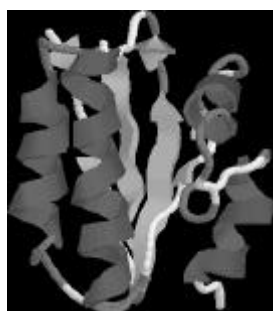

Pulse Calibration

2

Proper optimization of the pulse lengths is essential in biomolecular NMR where the sample concentrations often are minimal. Besides, in the pulse sequences with many RF pulses the sensitivity losses due to pulse imperfections accumulate.

RF routing

2.1

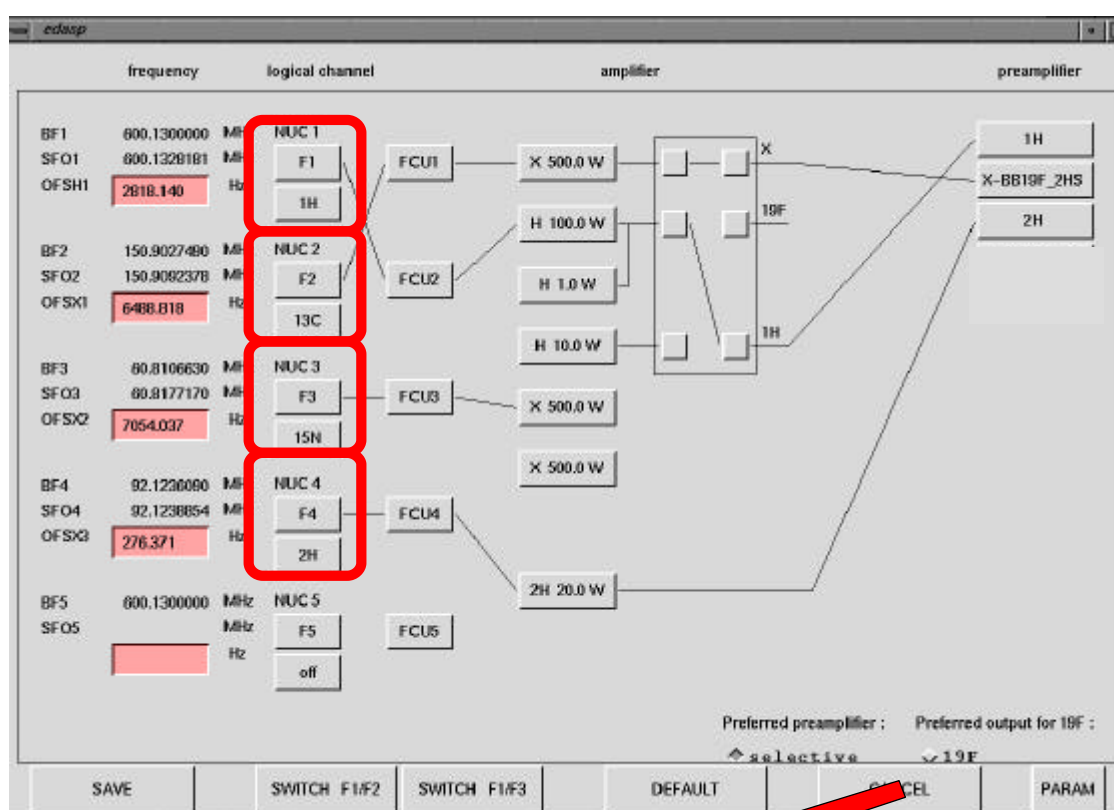

Fig. 10. RF-routing.

Enter the **edasp** display and select the RF-routing for triple resonance in the following way (note that the ^2H through the 4th channel is optional). Tune and match the ^{15}N , ^{13}C and ^1H channels.

If the console is equipped with the 2H-TX board: for the above 4th channel routing the connection to the 2H-TX board should be recabled from input-3 RI3(YIN) on the *first* router board to output-1 RO1(XYI) on the *second* router board. Change also 2H-TX address in the bsmstool from 3 to 7. This is done by typing in a UNIX window „bsms“, then select options 6, 8 and finally change the address to 7. Click on „save“ and do „cf“ in XWINNMR. With such cabling deuterium observe is possible only with special pulse programs (which use the syntax o1=o4).

¹H observe pulse 2.2

The ¹H pulse calibrations should be done on the actual biomolecular sample because they strongly depend on the ionic strength of the solution. If the concentration is sufficient, use the sequence **zgpr** and look at the protein signals. If the protein concentration is too low for accurate pulse calibrations, use pulse sequence **zg** monitoring the water signal. For detailed instructions see the manual for Bruker Avance 1D/2D course.

¹³C inverse mode 2.3

The ¹³C pulse calibrations should be done in the inverse mode (¹³C through the 2nd channel) using the pulse sequence **dec90**. For instance, the Bruker pulse calibration sample containing 0.1 M ¹³CH₃OH in DMSO-d₆ can be used. The ¹³C-offset for the methyl group in methanol is 49 ppm, the methyl ¹H-offset is 3.28 ppm and the 1-bond coupling constant is 142 Hz. For detailed instructions see the manual for Bruker Avance 1D/2D course.

¹⁵N inverse mode 2.4

The ¹⁵N pulse calibrations should be done in the inverse mode (¹⁵N through the 3rd channel) using the pulse sequence **dec90f3**. For instance, the Bruker pulse calibration sample with 0.1 M ¹⁵N-urea in DMSO-d₆ can be used. The ¹⁵N-offset for the amide groups in urea is 76 ppm, the amide ¹H-offset is 5.4 ppm and the 1-bond coupling constant is 89 Hz. The procedure is analogous to that for ¹³C in 2.3.

¹³C selective excitation/inversion, inverse mode 2.5

The ¹³C pulse calibrations should be done in the inverse mode (¹³C through the 2nd channel) using the pulse sequence **dec90sp** and **dec180sp**. For instance, the Bruker pulse calibration sample with 0.1 M ¹³C-CH₃OH in DMSO-d₆ can be used. You can also calculate the values by using the PROSOL Table in XWINNMR, **edprosol**.

Band selective excitation

The procedure is analogous to the pulse calibration in Chapter 2.3, except that for ^{13}C -excitation a shaped pulse instead of a hard pulse is applied. The pulse sequence starts with an initial proton magnetization that is allowed to dephase under the 1-bond scalar coupling to ^{13}C during $(2 \cdot J_{\text{CH}})^{-1}$. An antiphase signal is obtained, the intensity of which depends on the flip angle of the selective ^{13}C -pulse. When the ^{13}C -pulse is a perfect 90° -pulse, the magnetization is completely converted to a multiple quantum coherence and the observed signal reaches its *minimum*.

Table 2: Acquisition parameters for shaped ^{13}C 90° pulse calibration.

Parameter	Value	Comments
PULPROG	dec90sp	pulse program
NUC1	1H	nucleus on f1 channel
O1P	3.5 ppm	^1H offset
NUC2	13C	nucleus on f2 channel
O2P	49 ppm	^{13}C offset
NS	1	
DS	0	
CNST2	139	$^1J_{\text{CH}}$
PL2	120 dB	no ^{13}C hard pulses
P13		selective pulse length (320us, e.g.)
SP2		dB power level for selective pulse
SPNAM2	Q5.256	name of selective pulse
SPOAL2	0.5	phase alignment of selective pulse
SPOFF2	0.0	offset of selective pulse

Fig. 11. Shaped 90° - ^{13}C -pulse calibration (anti-phase signal).

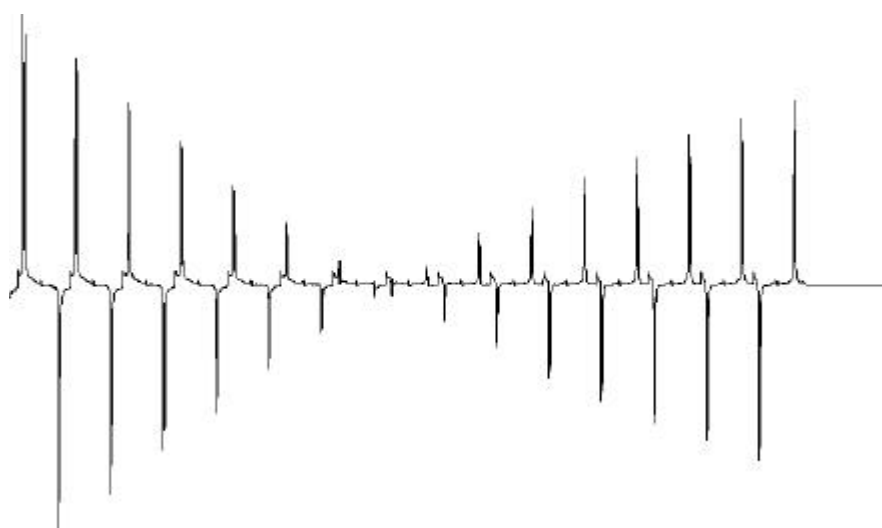

Selective inversion

The pulse sequence starts with an initial proton magnetization that is allowed to dephase under the 1-bond scalar coupling to ^{13}C during $(2 \cdot J_{\text{CH}})^{-1}$. Subsequently a hard 90° -pulse on the ^{13}C -nuclei creates a multiple quantum coherence. This coherence is refocused by the subsequent 180° - ^1H -pulse and a refocussing delay of $(2 \cdot J_{\text{CH}})^{-1}$, yielding an in-phase signal.

If the selective ^{13}C -pulse, applied after the 180° - ^1H -pulse, is a perfect 180° -pulse, the magnetization stays as multiple quantum coherence and the observed signal is *minimal*.

Table 3: Acquisition parameters for shaped ^{13}C 180° pulse calibration.

Parameter	Value	Comments
PULPROG	dec180sp	pulse program
NUC1	1H	nucleus on f1 channel
O1P	3.5 ppm	^1H offset
NUC2	13C	nucleus on f2 channel
O2P	49 ppm	^{13}C offset
NS	2	
DS	2	
CNST2	139	$^1J_{\text{CH}}$
PL2		^{13}C hard pulse power level
P3		^{13}C hard pulse length
P14		selective pulse length (256 μs , e.g.)
SP3		dB power level for selective pulse
SPNAM3	Q3.256	name of selective pulse
SPOAL3	0.5	phase alignment of selective pulse
SPOFF3	0.0	offset of selective pulse

Fig. 12. Shaped 180° - ^{13}C -pulse calibration (in-phase signal).

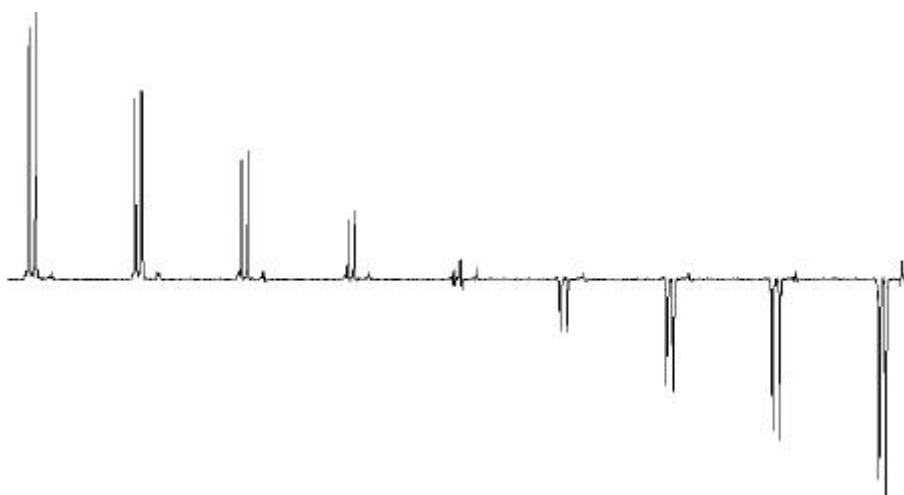

PROSOL Table of pulse lengths and power levels 2.6

For the (semi-)automated set-up of 3D/triple resonance experiments you should enter the pulse lengths and the corresponding power levels into the PROSOL table. Use the command **edprosol**. The super user password is required to edit this table. Fill in the rectangular pulses for ^1H , ^{13}C and ^{15}N for channels F1, F2 and F3, respectively, as illustrated in Fig. 13, and the soft pulses for ^{13}C as shown in Fig. 14.

Fig. 13. The 90-degree hard, decoupling and mixing pulses for ^{13}C , 2nd channel.

Description		pulse [usec]	power level		
90 deg. decoupler	P90	15	-2.1		
cpd	PCPDP	65	10.45	calc.	
bilev (second cpd)	PLCPD2		120		
		mix time [s]	pulse [usec]	power level	
toesy spin lock	PTOC		25	2.4	calc.
roesy spin lock	PROE		0	120	calc.
		field [Hz]	power level		
cw irradiation	PLCW		120	calc.	
NOE diff. irradiation	PLNOE		120	calc.	
homo decoupling	PLHD		120	calc.	
band homo decoupling	PLHC		120	calc.	

Fig. 14. The necessary soft pulses for ^{13}C through the 2nd channel.

Description:	Pulses:	P.Level:	Alignm.:	Name:	
90 excitation	PSH1	120	0.5	Gauss1.1000	<i>not used</i>
180 adia refocuss	PSH2	2000	2.4	Crp60comp.4	
180 adia inversio	PSH3	500	2.4	Crp60,0.5,20.1	
Cali/CO 90 on	PSH4	320	-0.8	Q5.1000	
Cali/CO 90 tr	PSH5	320	-0.8	Q5tr.1000	
Cali/CO 180	PSH6	256	0.4	Q3.1000	
Calpha sel 90	PSH7	410	1.6	Q5.1000	
Calpha sel 90 tr	PSH8	410	1.6	Q5tr.1000	
Calpha sel 180	PSH9	360	3.3	Q3.1000	
CO decoupling	PSH10	100us	2.4	Gauss5%.256	<i>advantage: shorter</i>
C sel 2 90	PSH11	120	0.5	Gauss1.1000	<i>not used</i>

²H decoupling pulse

2.7

The use of partially and/or fully ²H-labeled samples enables NMR investigations of larger biomolecules because the major cause of ¹³C line broadening and signal losses is eliminated, that is, the major source of the carbon relaxation (the dipolar coupling to the attached protons) is removed.

The calibration of the deuterium decoupling pulse is done on the ASTM sample consisting of 60% benzene-d₆ in p-dioxane. The following instructions refer to spectrometers equipped with a so called 2H-TX board in the console.

Since almost every probe is equipped with a deuterium lock channel, the only additional hardware required for deuterium decoupling is a free RF-channel and a switch, which allows alternating the lock channel between the locking and decoupling modes during the experiment. This switch is installed in the 2H-TX board. The board also contains a 20.0 W deuterium amplifier.

First do the ²H-recabling as described in the section 2.1 „RF-routing“. It is necessary to change the RF-routing to enable ¹³C observation. In the **edsp** display select 13C on the F1 channel. Deuterium should be routed from the F4 channel through the 20.0 W 2H-TX-amplifier because of the recabling. Save the RF-routing and exit the display. Now read in a pulse sequence called **decp902hf4**. This is the same experiment as used in Section 2.3 for the inverse pulse calibration, but modified to activate the 2H switch.

Table 4: Acquisition parameters for deuterium pulse calibration.

Parameter	Value	Comments
PULPROG	decp902hf4	pulse program
NUC1	13C	nucleus on f1 channel
O1P	128 ppm	¹³ C offset
NUC4	2H	nucleus on f4 channel
O4P	7.28 ppm	² H offset
NS	1	
DS	0	
CNST5	24	¹ J _{CD}
P1		¹³ C observe hard pulse
PI1		¹³ C power level
PI4		² H power level
P23		² H pulse (to be calibrated; 200-300us)

Fig. 15. Deuterium pulse calibration.

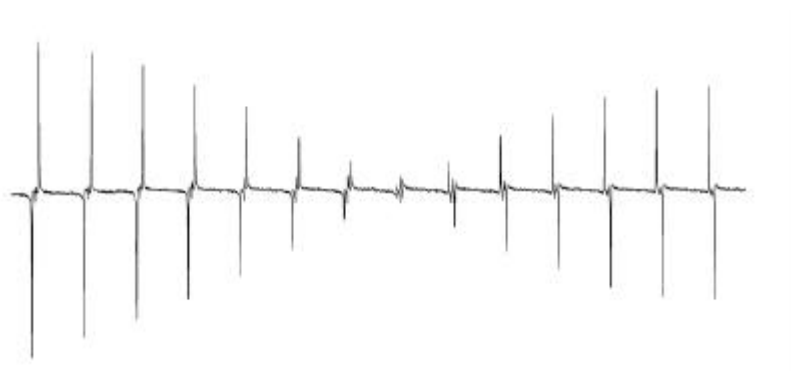

Since deuterium is a spin 1 nucleus the resulting spectrum contains a triplet instead of the doublet of a spin $\frac{1}{2}$ nucleus. Fig. 15 shows the zero crossing in the calibration. The value of p23 at the zero crossing corresponds to the 90° -deuterium pulse, for decoupling a value between 200us and 300 us is sufficient.

Delays

2.8

In most 3D experiments, J-couplings (see App. 13.1) are used to transfer magnetization from one nucleus to another one. The corresponding delays have been preset in the standard pulse programs to the optimized values reported in the original literature. You might want to change a value, for example, due to fast T_2 relaxation. This can only be done by modifying the value in the pulse program. We recommend you to start with the set values.

Table 5: Some predefined delays

Coupling const.	delay	length /ms	experiment	remarks
$(3 \cdot J_{CH})^{-1}$	d3	2.2		
$(4 \cdot J_{CH})^{-1}$	d4	1.6-1.8		
$(6 \cdot J_{CH})^{-1}$	d21	1.1		
$(2 \cdot J_{NH})^{-1}$	d21	5.5		
$(4 \cdot J_{C^{\alpha}C^{\beta}})^{-1}$	d22	4.0		
$(2 \cdot J_{C^{\alpha}C^{\beta}})^{-1}$	d22	3.6		2-bond
$(2 \cdot J_{C^{\alpha}C^{\beta}})^{-1}$	d22	4.4		1-bond
$(4 \cdot J_{NC})^{-1}$	d23	12.0		
$(4 \cdot J_{CC})^{-1}$	d24	3.6		
$(4 \cdot J_{NH})^{-1}$	d26	2.3		
T(N)	d21	12.4		
T(C)	d23	12.0		$2T=24ms \leq 1/4J_{CH}$

Summary of the calibrated pulse lengths**2.9**Table 6: ^1H -field: MHz Date:**F1-channel / ^1H**

nucl./shape	length/ μs	power/dB	comment
^1H	p1	pl1	90° hard pulse
	p6	pl10	90° mixing pulse (~25 μs)
			90° DIPSI decoupling (~40 μs)
	pcpd1	pl19	90° decoupling & ROESY (~100 μs)
Sinc1.1000	p11	sp1	90° water flip-back (~2ms)

F2-channel / ^{13}C

nucl./shape	length/ μs	power/dB	comment
^{13}C	p3	pl2	90° hard pulse
	p9	pl15	90° mixing pulse (~25 μs)
	pcpd2	pl12	90° decoupling (~50 μs)
Q5.256	p13	sp2	90° selective on-res.(320 μs) (60ppm)
Q5.256	p13	sp4/sp6	off-resonance
Q5tr.256	p13	sp8	on-res., time reversed
Q5.256			90° selective on-res.(410 μs)
Q3.256	p14	sp3	180° selective on-res.(256 μs)(60 ppm)
Q3.256	p14	sp5/sp7	off-resonance
Q3.256			180° selective (360 μs) (ca. 40 ppm)
Q3.256	p24	sp9	180° selective (768 μs) (ca. 24 ppm)
Gauss5%.100			180° selective for carbonyls (100 μs)

F3-channel / ^{15}N

nucl./shape	length/ μs	power/dB	comment
^{15}N	p21	pl3	90° hard pulse (~35 μs)
	pcpd3	pl16	90° decoupling (~200 μs)

F4-channel / ^2H

nucl./shape	length/ μs	power/dB	comment
^2H	pcpd4	pl17	90° decoupling (200-300 μs)

In the above Table the pulse lengths and power levels are denoted according to the Bruker nomenclature. The standard pulse programs use these conventions. A complete overview of the nomenclature is found on your spectrometer in the file `/u/exp/stan/nmr/lists/pp/Param.info`.

Preparatory 1D and 2D experiments

2.10

Having inserted your biomolecular sample, set the appropriate temperature, lock on H₂O, tune and match the probe head and perform gradient shimming. Thereafter, set-up a 1D-experiment using the **zgpr** pulse sequence. Optimize the ¹H-offset in the „gs“ mode for the maximal water suppression and determine the ¹H 90°-pulse length.

Fig. 16. Coupled ¹H 1D-spectrum of a ¹⁵N, ¹³C-labeled protein.

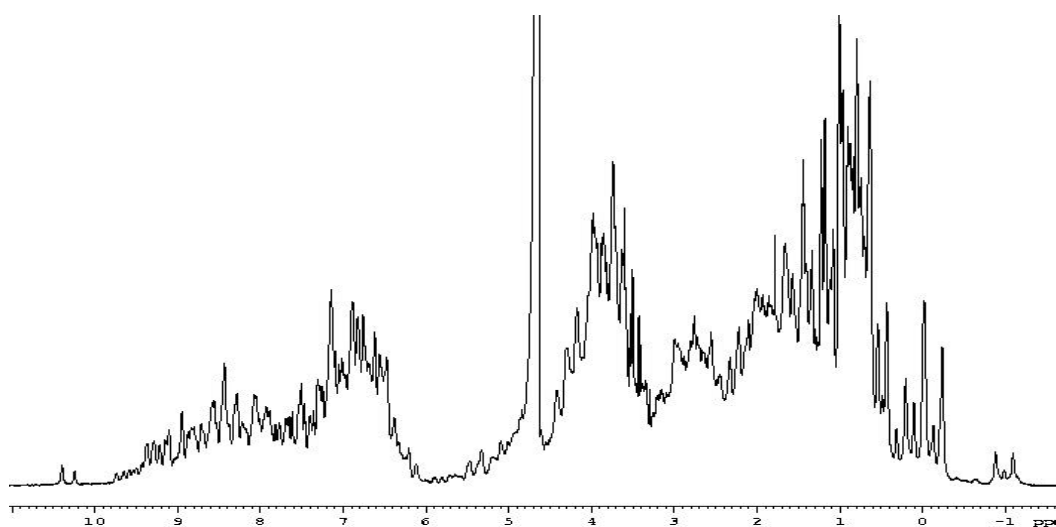

REGIONS: *amide* *aromatic* *alpha* *beta* *other-aliphatic* *methyl*

Now record the 2-dimensional ¹³C-HSQC and ¹⁵N-HSQC experiments in order to check your sample and the spectral quality. For the ¹³C-HSQC use the pulse sequence **hsqcetgpsi** and set the coupling constant to 135 Hz. For the ¹⁵N-HSQC use the pulse sequence **hsqcetgpsif3** and set the coupling constant to 92 Hz. Detailed descriptions of these two experiments are given in the manual for the Bruker Avance 1D/2D training course. This manual is can also found in the XWINNMR „help“ menu under „other topics“ with the name „Avance User´s Guide“.

The aliphatic- ^{13}C spectral width extends from 0 to 75 ppm and the aromatic- ^{13}C frequencies are located between 105 and 135 ppm. In the order to increase the resolution in the carbon-13 dimension without increasing the number of points - and thus the experiment time - the spectra can be folded (if MC2=TPPI) or aliased (if MC2=States or States-TPPI), see Fig. 17.

Fig. 17 . Folding and aliasing of the ^{13}C -dimension.

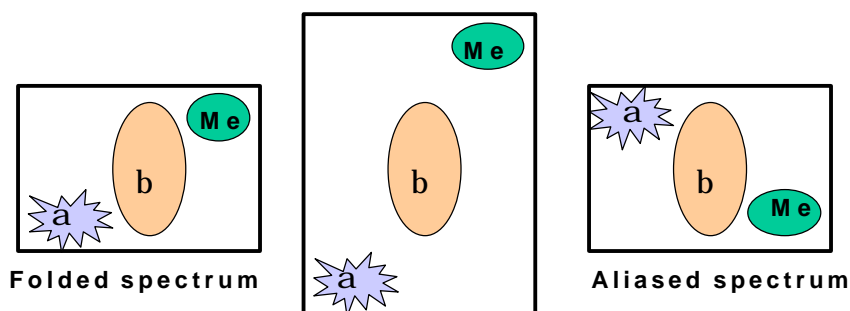
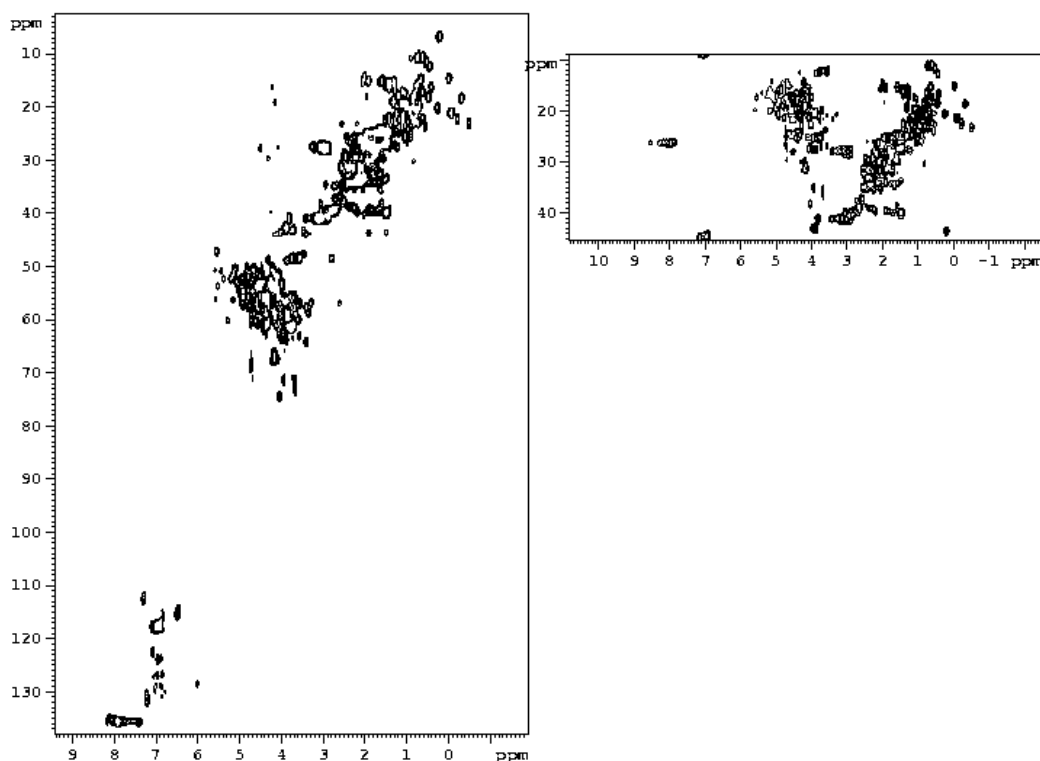

Fig. 18. Example of aliasing of the ^{13}C -dimension in the ^{13}C -HSQC spectrum.



In Fig. 18 the ^{13}C -spectral window has been reduced to one fourth and the position of the ^{13}C -offset has been chosen such as to minimize signal overlap in the resulting spectrum. The alpha and methyl carbon frequencies outside the spectral width become aliased. For additional information about ^{13}C -frequencies in polypeptides see Appendix 13.2.

^1H - ^{13}C TOCSY-HSQC

3

Introduction

3.1

Overlap in two-dimensional experiments such as NOESY and TOCSY is readily resolved by spreading the signals to a third dimension according to a heteronuclear frequency. The ^{13}C -edited TOCSY experiment consists of a ^1H - ^1H TOCSY and gradient selected ^1H - ^{13}C HSQC part. The information content of the experiment corresponds to the 2D TOCSY experiment, that is, magnetisation transfer takes place between scalar coupled protons within a so called spin system. The ^1H -signals are spread out to the additional dimension according to the ^{13}C chemical shift in order to alleviate overlap.

The flow of the magnetization is as follows

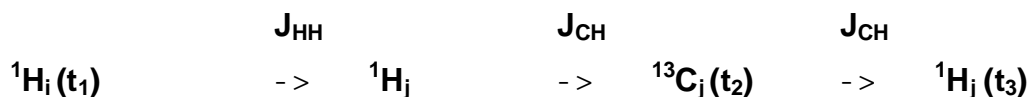

In a protein each residue forms a separate spin system because magnetization is not transferred over the backbone carbonyl group in this experiment. Hence the ^1H frequencies and the ^{13}C frequencies of their attached carbons can be identified in the ^{13}C -correlated TOCSY experiment.

References:

Experiments for recording pure-absorption heteronuclear correlation spectra using pulsed field gradients. A. L. Davis, J. Keeler, E. D. Laue, D. Moskau. J. Magn. Res. 98 (1992) 207-216.

Protein NMR Spectroscopy. J. Cavanagh, W. J. Fairbrother, A. G. Palmer III, N. J. Skelton. Academic Press Inc. (1996).

Pulse Sequence Diagram

3.2

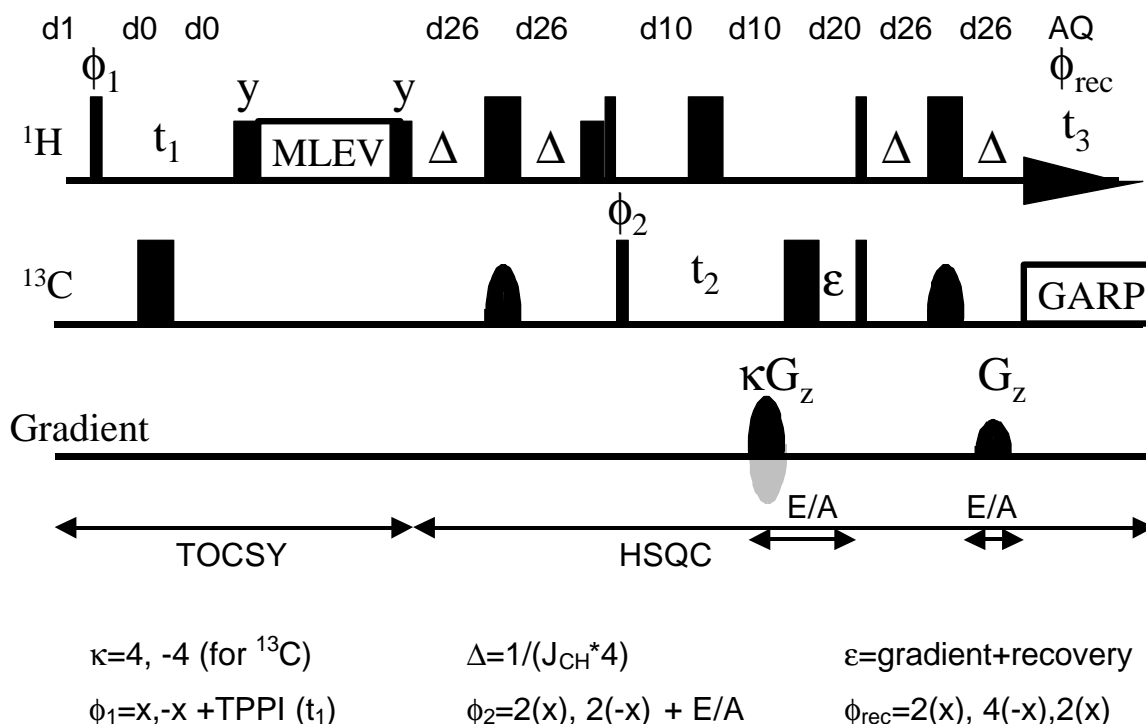
Fig. 19. ^1H - ^{13}C TOCSY-HSQC.

In the above diagram 90° -pulses are denoted by thin bars and 180° -pulses are denoted by thick bars. The two ^{13}C -inversion pulses are adiabatic. The pulse phases are x if not specified. On the bottom of the Figure the TOCSY and HSQC parts of the pulse sequence are indicated, as well as the pulses and delays that achieve the heteronuclear gradient echo (echo-antiecho processing, E/A).

The trim pulses before and after the TOCSY mixing suppress solvent and artifactual coherences perpendicular to the coherence of interest. The amplitude of the first gradient should add up to 3.976 times the amplitude of the last gradient in order to select the ^{13}C -coherences (as the ratio of the magnetogyric ratios $\gamma(^1\text{H})/\gamma(^{13}\text{C})$ is 3.976). For the echo-antiecho (E/A) coherence selection the amplitude of the first gradient is inverted together with the phases of receiver and the two ^{13}C -pulses preceding t_2 . For each t_1 -increment the phase ϕ_1 is incremented.

There is a trade off between the number of points in the indirect dimensions and the number of transients that can be recorded within a reasonable time. Particularly in the indirect ^1H -dimension the digital resolution needs to be sufficient to resolve cross signals. Consequently the phase cycle has to be kept short. Here a minimal phase cycle is employed, two steps for the isotope filter and two steps for the axial peak suppression in t_1 and t_2 .

Setting up the experiment

Sample: 50 mm unlabeled cyclosporin (12 a.a.) in benzene- d_6 .

Experiment time: 16.5 hours.

First record a 1D-spectrum to determine the required ^1H sweep width and to optimize the ^1H set-up. Type **ixpno** to create and enter a new experiment. Invoke the **edsp** display in order to set up the RF-channel routing. The current pulse sequence uses the second channel for ^{13}C -excitation. Depress the off-button underneath the F2-button and select ^{13}C and simply click on the **default setting** button. Click on **save** upon leaving the display. Now change to 3D parameter mode by typing **parmode** and selecting **3D**. The program will ask you whether you want to delete the existing meta etc. files, answer yes. Enter the following values by using **eda** display for defining the three dimensions and the **ased** command which invokes only the parameters that are active in the particular experiment.

Table 7: Acquisition Parameters

Parameter	Value	Comments
PULPROG	mlevhsqcetgp3d	pulse program
NUC1	1H	nucleus on f1 channel
O1P	4.7 ppm	^1H offset
NUC2	13C	nucleus on f2 channel
O2P	39 ppm	^{13}C offset
PL1		high power level f1 channel (^1H)
PL10		power level for TOCSY mixing (^1H)
PL2		high power level f2 channel (^{13}C)
PL12		decoupling power level f2 channel (^{13}C)
SP3	=25us hard pulse	adiabatic inversion, power as 25us 90°
SPNAM3	Crp60,0.5,20.1	0.5ms smooth CHIRP (adiabatic inv.)
P1		90° ^1H pulse (f1 channel)
P2	preset to 2^*p1	180° ^1H pulse (f1 channel)
P5	set to 0.667^*p1	60° pulse for TOCSY mixing (f1)
P6	25-30u	90° pulse for TOCSY mixing (f1)
P7	preset to 2^*p6	180° pulse for TOCSY mixing (f1)
P14	500u	Legth of adiabatic inversion 180 pulse $^\circ$
P17	2000u	low power trim pulse (f1)
P28	0u	high power trim pulse (not applied!)
P3		90° ^{13}C pulse (f2 channel)
P4	preset to 2^*p3	180° ^{13}C pulse (f2 channel)

^1H - ^{13}C TOCSY-HSQC

Parameter	Value	Comments
D1	1.5 s	recycle delay
D9	60 ms	TOCSY mixing time
CNST2	135	J_{CH} couplingconst., $D26=1\text{s}/(\text{CNST}4*4)$
P16	1000 us	gradient length
D16	50 us	gradient recovery (50-100 us)
GPNAM1	SINE.100	#1 gradient name
GPNAM2	SINE.100	#2 gradient name
GPZ1	80	#1 gradient amplitude
GPZ2	20.1	#2 gradient amplitude
NS	4	number of scans
DS	128	number of dummy scans; multiple of ns
CPDPRG2	garp	decoupling scheme f2 channel (^{13}C)
PCPD2		decoupler pulse length f2 channel (^{13}C)
ZGOPTNS	-	leave empty for unlabeled sample
P14	500u	adiabatic inversion pulse
SP3		power equal to 25us 90 ⁰ -pulse
SPNAM3	Crp60,0.5,20.1	adiabatic inversion pulse
SPOFF3	0.0	
SPAL3	0.5	
F2 indirect ^{13}C	*****	(middle column)
FnMODE	echo-antiecho	XWIN-NMR 3.0 and onwards
TD	64	number of real points
SW	75 ppm	sweep width indirect ^{13}C
ND10	2	no of in10 in pulse program
F1 indirect ^1H	*****	(rightmost column)
FnMODE	States-TPPI	(or TPPI, in that case: ND0=4)
TD	128	number of real points
SW	12 ppm	sweep width ^1H
ND0	2	(Note: if FnMODE=TPPI, ND0=4)

Note that the delays d0 and d10 are set automatically and that the increments are calculated through $\text{in}0=[\text{nd}0*\text{sw}(\text{F}1)]^{-1}$ and $\text{in}10=[\text{nd}10*\text{sw}(\text{F}2)]^{-1}$. The acquisition time AQ is set through $\text{AQ}=\text{TD}/\text{SW}*2$. Therefore, these parameters are not reported above.

To inspect and edit the pulse program type **edcpul** on the command line. To view the pulse program as the pulse sequence diagram, type **ppg** on the command line. Before starting an experiment, you may check the receiver gain automatically with the **rga** command and the total measurement time with the **expt** command. High receiver gain (~32k) is necessary in this case.

The individual parameters for each dimension can be called for on the command line by typing, for instance,

td (reports the number of points set in F3)

2 td (reports the number of points set in F2)

1 td (reports the number of points set in F1).

While the experiment is running, the actual status of it can be monitored by the commands

2s td (reports the number of points recorded in F2)

1s td (reports the number of points recorded in F1).

Recording the two 2D planes

3.4

In order to test the experimental set-up and the quality of the spectrum, it is highly recommended to initially record the corresponding two 2D experiments, that is, the ^1H , ^1H -NOESY with only ^{13}C -bound protons selected in the acquisition dimension („13“) and the ^1H , ^{13}C -HSQC plane („23“). In XWIN-NMR create and enter a new experiment with the command **ixpno**. The individual planes can be recorded by using the 3D parameters and setting the number of points collected, **td**, in the inactive dimension to 2.

Inspection of 2D planes

First enter the **edp** display and insert the appropriate processing parameters from Table 6 below. To inspect the 2D planes in a 3D experiment, you can either click on the button **CREATE 2D** in the 3D data set, or just simply type **xfb** on the command line. The program will ask you the following questions.

Select direction? 13 or 23. In the present experiment **13** corresponds to the ^1H - ^1H NOESY and **23** corresponds to the ^1H - ^{13}C HSQC.

Enter slice number? You can inspect the different planes one by one, start with the first one.

Enter 2D procno? - You can choose any number except, of course, processing number 1 where the 3D is stored.

The program will now change to a 2D display and perform the processing using appropriate parameters from the 3D. Phase correct the 2D spectrum if necessary.

Phase corrections

Record the two 2D experiments and process them with the appropriate processing parameters given in Table 6. Phase the spectra and note the correction **phc0** and **phc1** values needed for the indirect dimension in each spectrum. Save the phase corrections for the 3D spectrum by returning, **rep 1**, and entering them in **edp**.

Observe that in the echo-anti-echo type of experiments the required zeroth order phase correction (phc0) in the acquisition dimension of the HSQC-plane differs -90° from the value required for the correct phasing of the ^1H - ^1H -plane. The appropriate value for the F3 dimension in the 3D processing is the value determined for the ^1H - ^{13}C HSQC plane.

In the indirect dimensions phase any deviations are due to phase evolution during the pulses within and flanking the particular evolution time. These effects can be compensated for by manipulating the first increment in the pulse sequence. For instance, the postacquisition phase corrections are phco=90 and phc1=-180 if the pulse sequence contains the statement: „d0=(in0-p22)/2-p1*2/3.14“. Depending on the length of in0 this statement may, however, accrue a negative value. In that case, it should be modified to „d0=in0-p22/2-p1*2/3.14“ giving phco=180 and phc1=-360.

Window functions

Optimize the window functions interactively on 1D slices from the 2D planes by using the „**manual window adjust**“ option available in the **process** menu. which shows the window function and its impact on the fid and the spectrum simultaneously. First type **rser 1** to display and manipulate the first fid. Process it with **ef** and phase the spectrum. Now activate the „**manual window adjust**“ tool and optimize the window function of your choice. Upon returning save it with the option „**save as 2D & return**“. Now perform the fourier transform along the rows only with the command **xf2**. The interferograms are displayed. In the **utilities** menu click on the button „**column**“ and select a column which clearly contains some signal. You will move into 1D processing mode when you upon returning „**store the column as the ~TEMP experiment**“. Now repeat the previous procedure of manual window adjustment. As the number of points in the indirect dimensions of a 3D is limited, the best results are achieved by applying a window function which removes truncation artifacts, such as shifted sine bell, SINE, or squared sine bell, QSINE. The shifting is given as fractions of π , for instance, ssb=2 gives 90° shifted (= cosine window) and ssb=3 gives a 60° shifted sine bell. After having saved the optimized window, start the second fourier transform with the command **xf1** and inspect the result.

Spectrum Processing

3.5

Processing the 3D spectrum

You can monitor the measurement while it is running or after its completion by simply typing the command **xfb** to monitor the 2D planes. The program will ask you, which plane you wish to process and under which processing to store it, as described above in Chapter 3.3.

Invoke the **edp** display and set the following parameters.

Table 8: Processing parameters

Parameter	Value	Comment
F3 acquisition	*****	(leftmost column)
SI	2k	zero fill
WDW	QSINE	squared sine bell
SSB	3.3	70° shifted
PH_mod	pk	phase correction applied
PHC0		zero order phase correction
PHC1		first order phase correction
BC_mod	no	no automatic baseline correction
F2 indirect ^{13}C	*****	(middle column)
SI	128 or more	zero fill
MC2	echo-antiecho	
WDW	QSINE	squared sine bell
SSB	2	90° shifted
PH_mod	no	phase correction is not needed
ABSG	1	first order base line correction
BC_mod	no	no automatic baseline correction
F1 indirect ^1H	*****	(rightmost column)
SI	512	zero fill
MC2	States-TPPI	(or TPPI, see FnMODE)
WDW	QSINE	squared sine bell
SSB	2	90° shifted
PH_mod	no	phase correction
ABSG	1	first order base line correction
BC_mod	no	no automatic baseline correction

The fourier transforms of the three dimensions are performed by typing the commands **tf3 no**, **tf2 no** and **tf1 no**, respectively (the „no“ here means that the imaginary part of the processed data will not be stored on the disc). Instead, you can write a macro by typing **edmac** and a new name, for instance, **fast3dproc**, which contains the three fourier transform commands, each on a separate line.

Upon completion of the processing the message „3D PROCESSED DATA AVAILABLE“ appears on the screen. Now you can inspect the spectrum by clicking on the **display** button. The program will ask you which countour levels you wish to display, 23, 13 or 12. Answer „yes“ „no“ „no“, and do not store the compressed data, in order to save disc space. It may be necessary to reset the contour levels by **edlev**, an appropriate starting value is 10 000 000. You can inspect the projections of the spectrum by depressing the **project** and the **x90**, **y90** or **z90** buttons, or you can run the **movie** to monitor

the complete cube. In order to inspect the individual planes, click on the button **scan**. Now you can either manually or automatically scan through the planes in the three orthogonal directions. To activate the display depress the appropriate button, **23**, **13** or **12**.

Fig. 20. The ^1H - ^1H and ^1H - ^{13}C planes of the ^1H - ^{13}C TOCSY-HSQC spectrum.

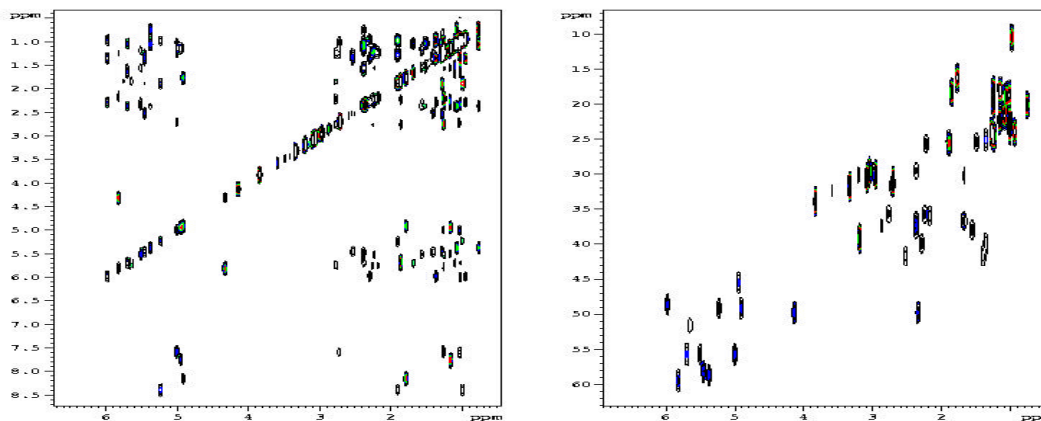

Additional processing parameters

3.6

A baseline correction with a polynomial can be applied to any of the three dimensions with the command **tabs1**, **tabs2** or **tabs3**. The order of the polynomial is given by the ABSG parameter for respective dimension. First order is recommended for simple removal of t_1 -noise. The range where the correction is applied is indicated by the ABSF1 and ABSF2 parameters. For instance, by setting these to 100 and 6 ppm the subsequent **tabs3** command will avoid the baseline correction in the vicinity and to the right of the water signal. In 2D spectra a baseline correction in the acquisition dimension which excludes the water signal within a user defined region, is invoked by the command **abs2.water**.

BC_mod when using digital acquisition should be set to „no“ „no“ „no“ when using digital quadrature detection (DQD). If post-acquisitional water deconvolution is needed, the baseline correction mode in F3 can be set to „**qpol**“ (a polynomial of 5th order is subtracted from the fid) or „**qfil**“ (filtering of the fid according to Marion, Ikura & Bax, JMR 84 (1989) 424-430). For the latter method the effective range of the filter should be set with the parameter BCFW. The parameter COROFFS applies to both methods and gives the correction offset from the center of the spectrum if the observation frequency o1 was not set on the water frequency.

PKNL should be set to **TRUE** for data collected in digital acquisition mode.

FT_mod is only activated for special transforms (performed using the „trf“ command).

If during the processing the command **tdeff** in any dimension is set to a value different from zero, only the specified number of points are used. Thus with the **tdeff** command points can be discarded from the end of the fid. To discard points from the beginning of the fid instead, the parameter **tdoff** defines the number of points with which the fid is left-shifted.

The spectrum is referenced by the command **sref**. The fine adjustment is done automatically with respect to the TMS signal as internal reference. If TMS is not used, type **sr 0**, **1 sr 0** and **2 sr 0** to make sure that the referencing is correct.

AQSEQ defines in which order the fids are recorded in the serial data file. A quick look at the beginning of the pulse program will tell you this. If the F1-dimension is incremented first, the inner loop in the pulse program contains the „id0“ command and in the outer loop this parameter is reset with the command „rd0“, then the order is 3-1-2, otherwise it is 3-2-1.

Linear prediction

3.7

Since the number of points in the indirect dimensions of a 3D spectrum is limited, it is useful to try linear prediction of additional points. Select **ME_mod LPfc** (forward prediction complex). The parameter **NCOEF** represents the number of coefficients used in the calculation. Ideally this parameter should be set to 2-3 times the number of expected peaks. The number of points used is **td**, except if **TDEFF** > 0, in which case **tdeff** points are used for the prediction. The number of predicted points is $2 \cdot \text{SI} - \text{TD}$, thus it replaces the zero-filling. Linear prediction and zero filling can also be combined by setting the parameter **LPBIN** to a value between **TD** and $2 \cdot \text{SI}$. In that case the points from **TD** up to **LPBIN** will be predicted and the remaining points up to $2 \cdot \text{SI}$ are set to zero. In the ^1H - ^{15}N NOESY-HSQC experiment below, the number of real points in the ^{15}N -dimension is 40. This number is extended to 60 by setting **LPBIN** to 60. The size of the final complex data matrix **SI** is 64, thus the points 61-128 are set to zero.

^1H - ^{15}N NOESY-HSQC

4

Introduction

4.1

The ^{15}N -correlated NOESY experiment consists of a ^1H - ^1H NOESY and ^1H - ^{15}N HSQC part. The sensitivity enhanced and gradient selected version of HSQC is implemented. Although the pulse sequence is longer, the relaxation of ^{15}N -nuclei is not usually so fast as to lead to relaxation losses due to the additional delays. Gradient selection also effectively suppresses the solvent signal. The pulse sequence also contains two defocusing gradients while the coherences of interest are stored along the z-axis. Furthermore, the phases of the proton pulses are chosen such as to realign the water magnetization to the +z-axis. These measures are taken in order to avoid saturation transfer from water to the NH-groups which undergo fast exchange. Thus it becomes possible to observe exchanging NH-signals up to neutral pH.

For protein studies the heteronucleus of primary choice is ^{15}N while ^{15}N -labeling is usually feasible and also less costly than ^{13}C -labeling. In the ^{15}N -correlated NOESY spectrum of a protein the signals are dispersed according to the backbone amide frequency of each residue. Thus the NOE connectivities between a backbone amide group and the spatially neighbouring protons, either within the same or in other residues, are observed. In the ^{15}N -HSQC experiment maximal sensitivity enhancement can be expected since all backbone amides are of the same multiplicity, that is, singly protonated.

The flow of the magnetization is as follows

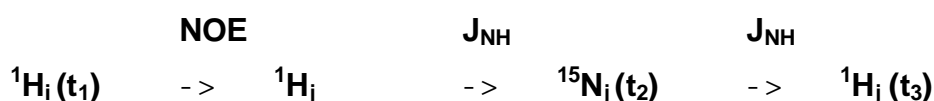

The ^{15}N -correlated NOESY experiment is usually combined with a ^{15}N -correlated TOCSY experiment. The latter yields the proton connectivities within each residue in a protein sequence. The sequential order of the residues can be traced by means of the NOE-connectivities, or through the triple resonance experiments if a ^{15}N , ^{13}C -labeled sample is available. It should be pointed out, however, that for larger molecules the ^1H - ^1H TOCSY transfer becomes less effective. The triple resonance experiment H(CCCO)NH actually confers identical information as ^{15}N -edited TOCSY, although the former relies on the transfer through ^{13}C - ^{13}C scalar couplings.

Pulse Sequence Diagram

4.2

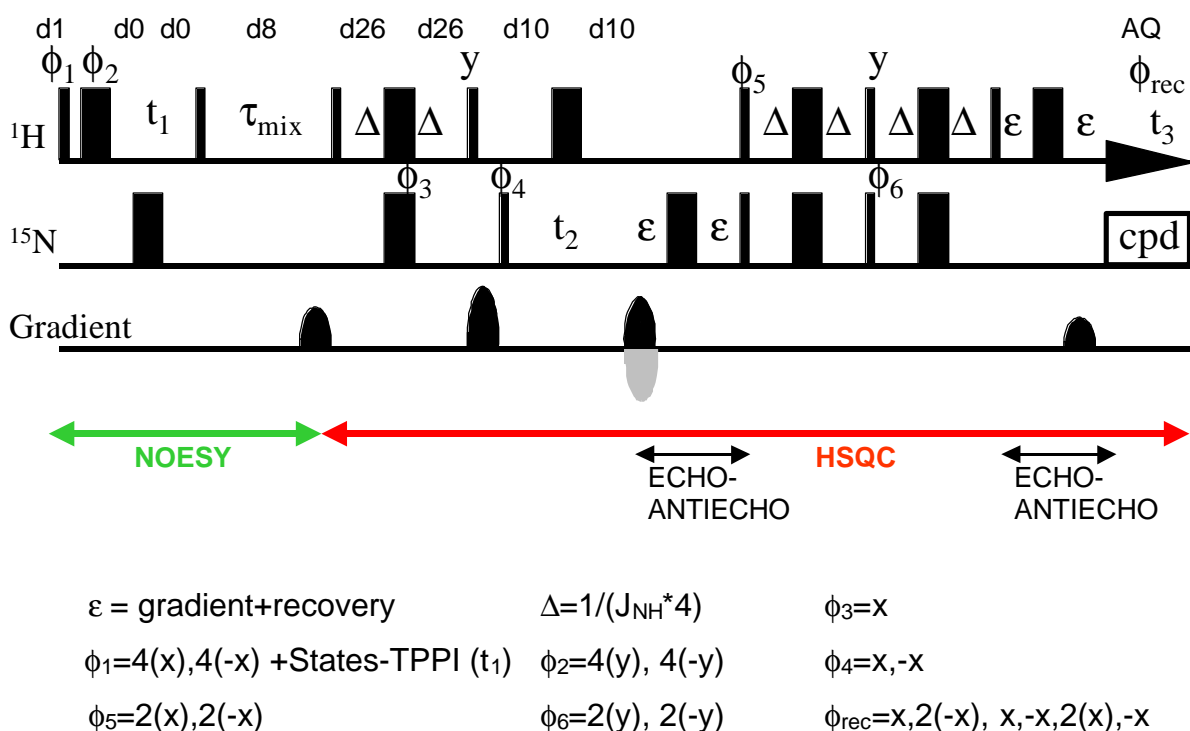
Fig. 21. ^1H - ^{15}N NOESY-HSQC.

In the above diagram 90° -pulses are denoted by thin bars and 180° -pulses are denoted by thick bars. The pulse phases are x if not specified. The phases of the ^1H -pulses are chosen such that the H_2O -magnetization is realigned along the $+z$ -axis. At the bottom the NOESY and HSQC parts of the pulse sequence are indicated, as well as the pulses and delays that achieve the sensitivity enhancement using a heteronuclear gradient echo selection (echo-antiecho). The first and second gradients defocus solvent and artifact coherences in the x - y plane while the magnetization of interest is aligned along the z -axis. Thus the amplitudes of these two gradients are arbitrary and can be optimized. The amplitude of the third gradient should be 9.862 times the amplitude of the fourth gradient in order to select the desired coherences (the ratio of the magnetogyric ratios $\gamma(^1\text{H})/\gamma(^{15}\text{N})=9.862$).

For the sensitivity enhancement in every second HSQC-plane the amplitude of the third gradient is inverted together with the phase ϕ_6 . For each t_2 -increment the phases ϕ_3 , ϕ_4 and the receiver are inverted. For each t_1 -increment the phases ϕ_1 and ϕ_2 are incremented.

References:

Improved Accuracy of NMR Structures by a Modified NOESY-HSQC Experiment. W. Jahnke, M. Baur, G. Gemmecker, H. Kessler. JMR 106 B (1995) 86-88.

Data Acquisition

4.3

Setting up the experiment

Sample: 1 mM ^{15}N - or ^{15}N , ^{13}C -labeled (requires ^{13}C -decoupling) polypeptide.

Experiment time: 24h

First record a 1D-spectrum to determine the required ^1H sweep width and to optimize the ^1H -offset (using the **gs**-tool, see below). Type **lexpno** to create and enter a new experiment. Invoke the **edsp** display in order to set up the RF-channel routing. The current pulse sequence uses the third channel for ^{15}N -excitation. Then change to 3D parameter mode by typing **parmode** and selecting 3D. The program will ask you whether you want to delete the existing meta etc. files, answer „yes“. Enter the parameters for the three dimensions in the **eda** and the rest in the **ased** display.

Table 9: Acquisition Parameters

Parameter	Value	Comments
pulse program	noesyhsqcetgpf 3gp3d	
NUC1	1H	nucleus on f1 channel
O1P	4.7 ppm	offset ^1H (optimized with „gs“)
NUC3	15N	nucleus on f3 channel
O3P	117 ppm	offset ^{15}N
PL1		high power level (f1 channel, ^1H)
PL3		high power level (f3 channel, ^{13}C)
PL16		decoupler power level (f3 channel, ^{13}C)
P1		90° ^1H pulse (f1 channel)
P2	set to 2*p1	180° ^1H pulse (f1 channel)
P21		90° ^{15}N pulse (f3 channel)
P22	set to 2*p21	180° ^{15}N pulse (f3 channel)
P28	1u	trim pulse, not used
D1	1.5 s	recycle delay
D8	100 ms	mixing time
CNST4	90	$d24=1\text{s}/(\text{CNST4}^4)$
P16	1000 us	gradient length
D16	50 us	gradient recovery
GPNAM1...2	SINE.100	gradient shape
GPZ1	80	#1 gradient amplitude

Parameter	Value	Comments
GPZ2	8.1	#2 gradient amplitude
NS	8	number of scans
DS	32	2*ns*x (because of echo-antiecho)
CPDPRG3	garp	decoupling scheme (^{15}N)
PCPD3		decoupler pulse length
ZGOPTNS	-DLABEL_CN	leave empty if only ^{15}N -labeled sample
P14	500u	adiabatic inversion pulse
SP3		power equal to 25us 90° -pulse
SPNAM3	Crp60,0.5,20.1	adiabatic inversion pulse
SPOFF3	0.0	
SPAL3	0.5	
F2 indirect ^{15}N	*****	(middle column)
FnMODE	echo-antiecho	XWIN-NMR 3.0 and onwards
TD	48	number of real points
SW	36 ppm	sweep width indirect ^{15}N
ND10	2	no of in10 in pulse program
F1 indirect ^1H	*****	(rightmost column)
FnMODE	States-TPPI	XWIN-NMR 3.0 and onwards
TD	128	number of real points
SW	14 ppm	sweep width indirect ^1H
ND0	2	no of in0 in pulse program

The „GS“ Interactive mode to optimize acquisition parameters

The gs command sets the spectrometer in a mode where acquisition parameters can be adjusted interactively while the first scan of the experiment is repeated. The impact of the adjustment can be observed either on the fid or on the spectrum. Start with the command **gs** and enter the acquisition window by typing **acqu**. Click on the iconified gs-window to open it and modify the parameters. In the DISPLAY menu, invoked through a button on the top bar, you can alternate between „**display time domain**“ or „**display frequency domain**“. The additional option „**phasing**“ allows you to display the spectrum with applying known phase corrections, or as a magnitude spectrum. A condition for the frequency domain display to work properly is a previously processed spectrum. It is worth noting that you can also perform shimming in the gs-mode.

For the current experiment you should optimize the ^1H -offset, **o1**. You can also test changing the amplitude of the first two gradients, gpz1 and gpz2. The desired effect upon changing any of these parameters is the minimization of the solvent signal.

Spectrum Processing**4.4****Table 10: Processing parameters**

Parameter	Value	Comment
F3 acquisition ^1H	*****	(leftmost column)
SI	2k	zero fill
WDW	QSINE	squared sine bell
SSB	3	70° shifted squared sine bell
PH_mod	pk	phase correction applied
PHC0		zero order phase correction
PHC1		first order phase correction
BC_mod	qpol	water deconvolution
BCFW	1	range for water deconvolution (in ppm)
ABSG	1	first order baseline correction
ABSF1	100 ppm	range for abs3 command
ABSF2	6 ppm	
STSR	0	- display only the left half of
STSI	1k	the spectrum (points 0-1024)
F2 indirect ^{15}N	*****	(middle column)
SI	128	zero fill
MC2	echo-antiecho	
WDW	QSINE	squared sine bell
SSB	2	90° shifted squared sine bell
PH_mod	pk	phase correction (only if needed)
PHC0		zero order phase correction
PHC1		first order phase correction
BC_mod	no	automatic baseline correction
ABSG	1	First order baseline correction
ABSF1	100 ppm	range for abs2 command
ABSF2	-100 ppm	
STSR	0	range for display
STSI	0	
ME_mod	LPfc	forward complex linear prediction
NCOEF	32	number of coefficients
LPBIN	64	extent of linear prediction
F1 indirect ^1H	*****	(rightmost column)
SI	512	zero fill
MC2	States-TPPI	
WDW	QSINE	squared sine bell

Parameter	Value	Comment
SSB	2	90° shifted squared sine bell
PH_mod	pk	phase correction
PHC0		zero order phase correction
PHC1		first order phase correction
BC_mod	no	automatic baseline correction
ABSG	1	first order baseline correction
ABSF1	100 ppm	range for abs1 command
ABSF2	-100 ppm	
STSR	0	range for display
STSI	0	

Broadband, adiabatic and selective ^{13}C decoupling 4.5

Broadband decoupling

If you are measuring on a ^{13}C , ^{15}N -labeled sample you should implement ^{13}C -decoupling during the ^1H -evolution, in order to prevent the splitting of the alpha-proton signal due to coupling to the bound carbon. You can achieve this in two ways, either by adding a 180-degree refocussing pulse or using composite pulse decoupling, „cpd“.

Insert a 180° ^{13}C -pulse in the middle of the ^1H -evolution, centered with respect to the 180° ^{15}N -pulse. In the beginning of the pulse program type „CEN_HC2=(p22-p4)/2“ and then

```
d0 pl2:f2
(p22 ph0):f3 (CEN_HC2 p4 ph0):f2
d0 pl12:f2
```

Now add composite pulse decoupling during acquisition

```
go=2 ph31 cpd2:f2 cpd3:f3
d1 do:f2 do:f3 wr *0 if *0 zd
```

Pay particular attention to set the power level and the decoupler-off commands (do:f2) correctly.

Thus, for broadband ^{13}C -decoupling the following parameters are needed:

CPDPRG2	garp	decoupling program
PCPD2		decoupling pulse length
PL12		decoupling power level
PL2		hard pulse power level
P4		180° hard pulse

Adiabatic decoupling

You might want to use the adiabatic ^{13}C -decoupling while it enables lower power, and thus, less heating. An appropriate power level is +2dB with respect to the power level determined for ^{13}C -GARP-decoupling. You can create the shaped pulse CHIRP95 optimized for minimal sidebands, with the „shape tool“, **stdisp**. Select the shape „smoothed chirp“, change the total sweep width to 40 000 Hz and the length of pulse to 1500us. Save it under the name CHIRP95. Set the following parameters:

CPDPRG2	p5m4sp180	decoupling program
PCPD2	1.5m	decoupling pulse length
PL12		decoupling power level
SP15	=pl12	note: + 2dB compared to garp
SPNAM15	CHIRP95	adiabatic shaped pulse

Selective decoupling

In some cases it is necessary to use selective ^{13}C -decoupling, for instance on the carbonyls or alpha-carbons (Section 10.3). Set the following parameters:

CPDPRG2	mlev180sp	decoupling program
PCPD2	768u	decoupling pulse length
PL12		decoupling power level
SP15	=pl12	
SPNAM15	Q3.256	selective 180° pulse
SPOFF15		^{13}C -offset for selective decoupling

Fig. 22. The ^1H - ^1H and ^1H - ^{15}N planes of the ^1H - ^{15}N NOESY-HSQC spectrum.

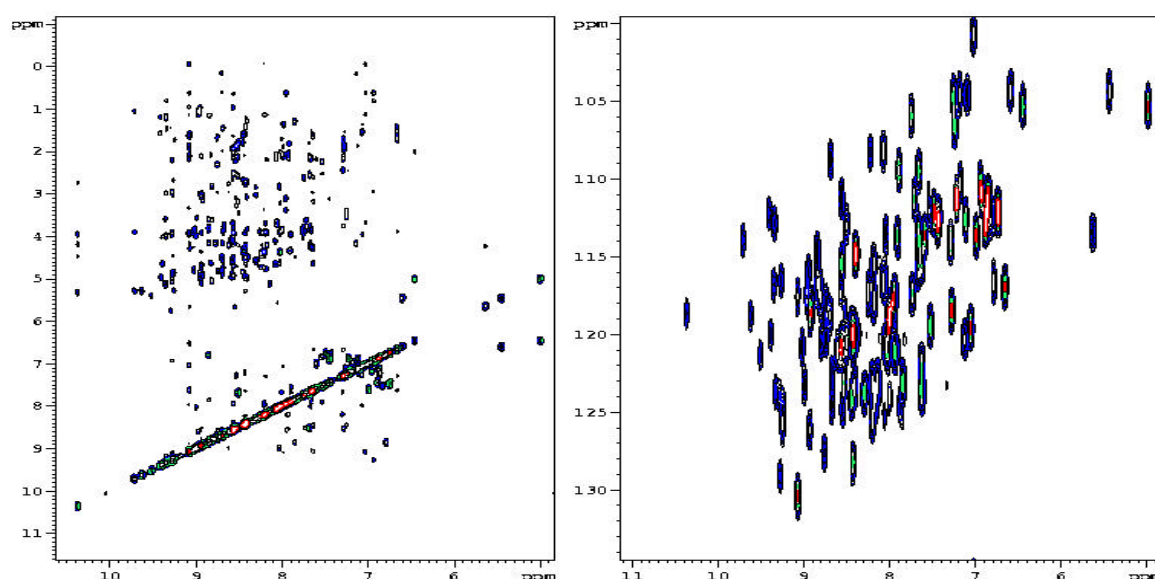

Introduction**5.1**

The three-dimensional HNHA experiment is designed to accurately determine three-bond H^N-H^α J-coupling constants. First, problems with overlap are alleviated by spreading the signals to an additional dimension according to the ^{15}N -frequency. Second, the coupling constant is determined from the ratio between the intensities of the diagonal and cross-peak which are readily quantized. The magnetization transfer is of HMQC-type involving the zero- and double quantum coherences. Therefore the signals are not modulated by the one-bond HN-coupling. The ^{15}N -evolution occurs in a constant time fashion and it is incorporated into the periods during which also the magnetization transfer from the H^N to the H^α coherence takes place. This magnetization transfer is proportional to the length of the transfer period (denoted below by 2ϵ) and the size of the H^N-H^α scalar coupling. Finally the coupling constant is deduced from the relation

$$\text{Intensity}(\text{cross peak}) / \text{Intensity}(\text{diagonal peak}) = -\tan^2(2\pi\epsilon J_{HN^\alpha})$$

Note that the diagonal and cross peaks in the resulting spectrum have opposite phase. The flow of the magnetization in the HNHA experiment is as follows

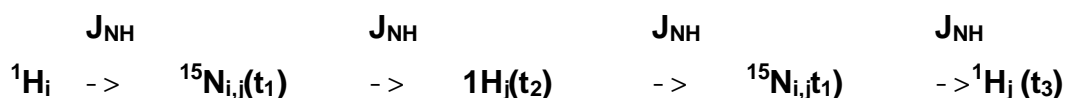

In proteins the three-bond H^N-H^α J coupling constants are an important source of information on the secondary structure and improve convergence and accuracy of the structure calculation particularly for α -helical fragments. Accurate determination of the H^N-H^α couplings is, however, complicated by their small size relative to the natural proton line width. A direct measurement is possible only for very small peptides, and also 2D methods combined with curve fitting to the fid become insufficient for proteins over 10 kDa.

References:

Quantitative J Correlation: A new approach for measuring homonuclear three-bond $J(H^N-H^\alpha)$ coupling constants in ^{15}N -enriched proteins. G. W. Vuister & A. Bax. JACS 115 (1993) 7772-7777.

Measurement of H^N-H^α J couplings in calcium-free calmodulin using new 2D and 3D water-flip-back methods. H. Kuboniwa, S. Grzesiek, F. Delaglio & A. Bax. J. Biomol. NMR 4 (1994) 871-878.

Protein NMR Spectroscopy. J. Cavanagh, W. J. Fairbrother, A. G. Palmer III, N. J. Skelton. Academic Press Inc. (1996).

Pulse Sequence Diagram

5.2

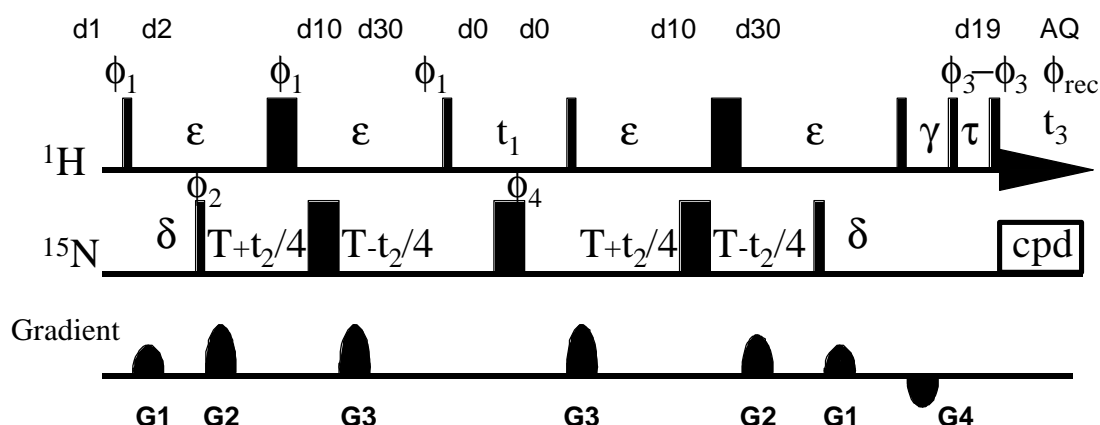

Fig. 23. HNHA.

$$\begin{array}{lll} \varepsilon = 13.5 \text{ ms} & & \delta = 1/(J_{\text{HN}\alpha} * 2) \\ \phi_1 = 2x, 2(-x) + \text{TPPI}(t_1) & \phi_2 = x + \text{TPPI}(t_2) & \phi_3 = 4x, 4y \\ \phi_{\text{rec}} = x, 2(-x), x, y, 2(-y), y & \gamma = \text{gradient} + \text{recovery} & \tau = 90 \mu\text{s} \end{array}$$

In the above diagram narrow and wide pulses denote 90° - and 180° -flip angles, respectively. The pulse phases are x if not specified. The first heteronuclear pulse creates zero- and double-quantum coherences in a HMQC type fashion. Simultaneous displacement of the first and the third heteronuclear 180° pulse during the subsequent delays, of total duration $4T+t_2$, causes chemical shift labeling of the ^{15}N -nucleus in a constant time manner. The gradient amplitudes should fulfill $G_1+G_2=G_3$, for instance, $G_1=30$, $G_2=45$, $G_3=75$. The last gradient dephases residual magnetization in the x,y -plane while the coherence of interest is align along the z -axis. The first gradient amplitude is arbitrary and should be optimized. The decrement $d30$ is automatically set equal to the increment $d10$ in the pulse program. To inspect the crossing of the last pair of 180° -pulses, the pulse program simulation tool **pulsdisp** found in the WINDOWS menu, can be used. The phases of the ^1H -pulses have been chosen such that the H_2O -magnetization is realigned along the $+z$ -axis.

Solvent suppression is achieved by a flip-back method also known as the jump-and-return or 1-1 technique. For this purpose two additional 90° -pulses on-resonance for water, flanking a delay τ , are applied prior to the acquisition. During the delay τ the off-resonance frequencies precess in the x,y -plane. The last 90° -pulse brings water back to the z -axis, thus avoiding solvent saturation, whereas for the off-resonance frequencies the excitation profile becomes frequency dependent with a maximum at offset $\pm 1/4 * \tau$.

Data Acquisition**5.3**

Sample: 1mM ^{15}N - or ^{15}N , ^{13}C -labeled (requires ^{13}C -decoupling) polypeptide.

Experiment time: 16.5h

Table 11: Acquisition Parameters

Parameter	Value	Comments
F3 acquisition	*****	<i>(leftmost column)</i>
PULPROG	hnhagp3d	
NUC1	1H	nucleus on f1 channel
O1P	4.7 ppm	offset ^1H (optimized with „gs“)
NUC3	15N	nucleus on f3 channel
O3P	117 ppm	offset ^{15}N
PL1		high power level f1 channel
PL2	120	Pops up if LABEL_CN is selected
PL0	120	
PL3		high power level f3 channel
P1		90° ^1H pulse (f1 channel)
P2	set to 2*p1	180° ^1H pulse (f1 channel)
P11	2000u	water flip-back (optimize in gs -mode)
SP1	ca. 46	water flip-back (optimize in gs -mode)
SPNAM1	square.1000	water flip-back pulse
SPOFF1	0.0	on-resonance for water
P21		90° ^{15}N pulse (f3 channel)
P22	set to 2*p21	180° ^{15}N pulse (f3 channel)
D1	1.5s	recycle delay with presaturation
D24	preset 4.5 ms	$1/2$ (J_{HN})
D23	preset 13.5ms	$\leq J_{\text{HNH}\alpha}$
P16	600u	gradient length
D16	50u	gradient recovery
GPNAM1...4	SINE.100	gradient pulse name
GPZ1	30	#1 gradient amplitude
GPZ2	45	#2 gradient amplitude
GPZ3	75	#3 gradient amplitude
GPZ4	20	#4 gradient amplitude
NS	16	number of scans
DS	16	number of dummy scans
CPDPRG3	garp	decoupling scheme (^{15}N)
PCPD3		^{15}N decoupler pulse length (f3 channel)
PL16		^{15}N decoupler power level (f3 channel)

Parameter	Value	Comments
TD	1024	number of points
SW	14 ppm	sweep width
AQ_MOD	DQD	digital quadrature detection
ZGOPTNS	-DLABEL_CN	leave empty if only ¹⁵ N-labeled sample
P8	500u	adiabatic inversion pulse
SP13		power equal to 25us 90°-pulse
SPNAM13	Crp60,0.5,20.1	adiabatic inversion pulse
SPOFF13	0.0	
F1 indirect ¹H	*****	(middle column)
FnMODE	States-TPPI	XWIN-NMR 3.0 and onwards
TD	128	number of real points
SW	14 ppm	sweep width ¹ H
ND10	2	no of in10 in the pulse program
F1 indirect ¹⁵N	*****	(rightmost column)
FnMODE	States-TPPI	XWIN-NMR 3.0 and onwards
TD	40	number of real points
SW	35 ppm	sweep width indirect ¹⁵ N
ND0	4	no of in10 in the pulse program
IN20	=IN0	set CT-decrement in20 equal to in0

„GS“ Interactive mode to optimize acquisition parameters

For the current experiment you should optimize the ¹H-offset, **o1**, and **phcor12** which changes the phase of the second jump and return 90°-pulse. This pulse phase should be optimized in very small steps, ~0.01 degrees at a time. The same result can be achieved by optimizing the length of the second ¹H-pulse in steps of 12.5 ns. These parameters are optimized to minimize the solvent signal.

Spectrum Processing

5.4

Table 12: Processing parameters

Parameter	Value	Comment
F3 acquisition	*****	(leftmost column)
SI	2k	zero fill
WDW	QSINE	squared sine bell
SSB	3	70° shifted
PH_mod	pk	phase correction applied
PHC0		zero order phase correction
PHC1		first order phase correction

HNHA

Parameter	Value	Comment
BC_mod	qpol	no automatic baseline correction
STSR	0	- display only the left half of
STSI	1k	the spectrum (points 0-1024)
F2 indirect ^{15}N		<i>(middle column)</i>
SI	128	zero fill
MC2	States-TPPI	
WDW	QSINE	squared sine bell
SSB	2	90° shifted
PH_mod	no	phase correction
BC_mod	no	no automatic baseline correction
F1 indirect ^1H		<i>(rightmost column)</i>
SI	512	zero fill
MC2	States-TPPI	
WDW	QSINE	squared sine bell
SSB	2	90° shifted
PH_mod	pk	phase correction
BC_mod	no	no automatic baseline correction

Fig. 24. The ^1H - ^1H plane of HNHA.

Nb. Crosspeaks are negative.

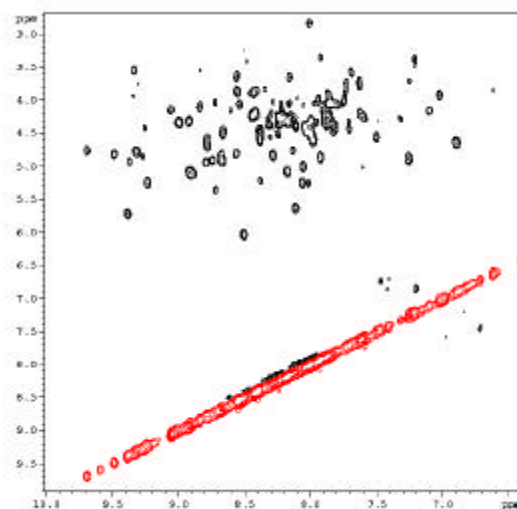

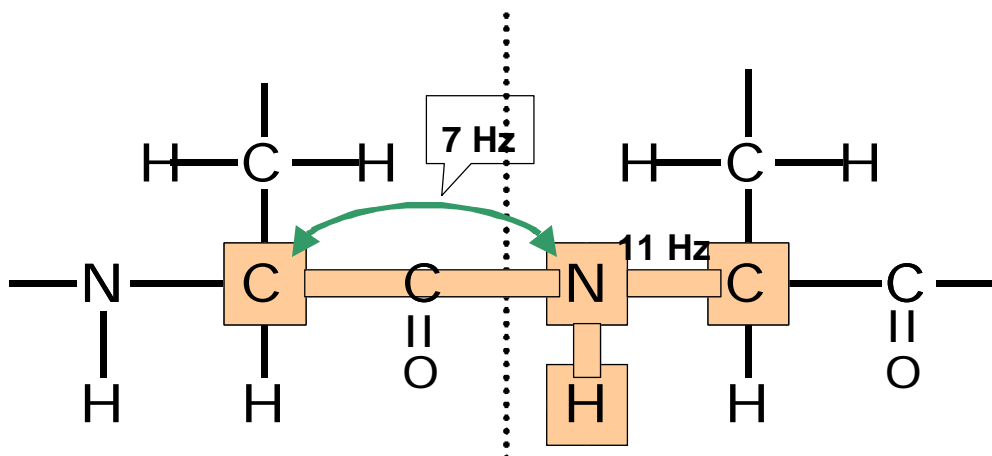
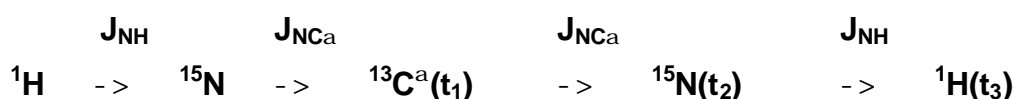

Fig. 25. Magnetization transfer in the HNCA experiment.

The HNCA experiment provides two types of correlations, namely the correlations from the backbone amide resonances H^N_i and N_i to the alpha-carbon C^α_i within the same residue, and to the alpha-carbon C^α_{i-1} of the preceding residue. This is because the two coupling constants, $^1J_{N_iC^\alpha_i}$ (=11 Hz) and $^2J_{N_iC^\alpha_{i-1}}$ (=7 Hz) are of similar size. Since only the latter, the sequential connectivity, is observed in the HN(CO)CA experiment, combining information from HNCA and HN(CO)CA yields unambiguous sequential correlations. The HNCA experiment consists of four coherence transfer steps. The flow of the magnetization is the following:



The magnetization transfer in the second and third steps, between ${}^{15}N$ and ${}^{13}C^\alpha$ can take place via a single quantum (INEPT-type) or multiple quantum (HMQC-type) coherence. The former, the single quantum experiment, is presented here. Its advantage is that the ${}^{15}N$ spin part does not undergo transverse relaxation since it stays longitudinal during the ${}^{13}C$ -evolution time.

References:

Improved 3D triple resonance NMR techniques applied to a 31 kDa protein. S. Grzesiek & A. Bax. J. Magn. Res. 96 (1992) 432-440.

Minimization of sensitivity losses due to the use of gradient pulses in triple-resonance NMR of proteins. J. Stonehouse, R. T. Clowes, G. L. Shaw, J. Keeler & E. D. Laue. J. Biomol. NMR 5 (1995) 226-232.

Pulse Sequence Diagram

6.2

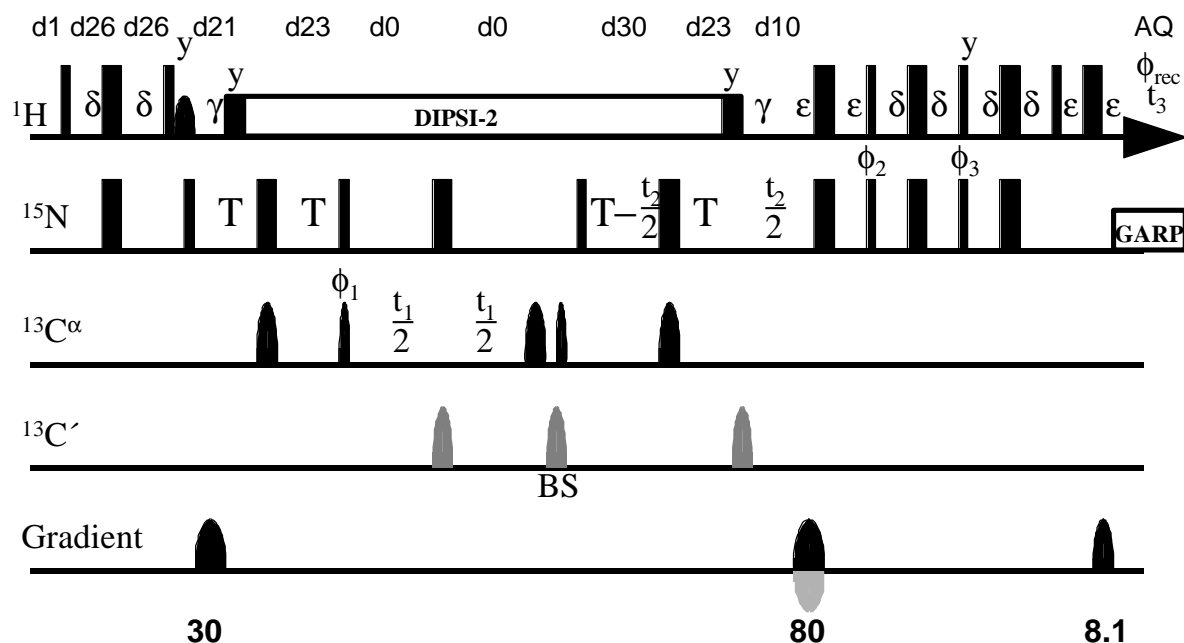

Fig. 26. HNCA.

	$\phi_2 = X, X, -X, -X$	$\phi_1 = X, -X + \text{States-TPPI } (t_1)$
$\phi_3 = Y, Y, -Y, -Y + \text{echo-antiecho}(t_2)$	$\phi_{\text{rec}} = X, -X, -X, X$	$\delta = 2.3 \text{ ms}$
$\epsilon = \text{gradient+recovery}$	$\gamma = 5.5 \text{ ms}$	$T = 12.0 \text{ ms}$

The sequence starts with an INEPT transfer of the magnetization from the backbone ^1H to ^{15}N . A dephasing delay T follows, during which the 1-bond coupling between ^{15}N and $^{13}\text{C}^\alpha$ leads to an antiphase three-spin coherence $H_z N_x C_z^\alpha$. This is converted to $H_z N_z C_y^\alpha$ by the first selective ^{13}C 90° -pulse and labeled by the $^{13}\text{C}^\alpha$ chemical shift during the t_1 -evolution time. It is converted back to the $H_z N_y C_z^\alpha$ antiphase coherence by the time reversed ^{13}C 90° -pulse. This pulse is time reversed in order to accomplish a pure 90° -rotation in the reverse direction, that is, from the transverse plane back to the z-axis.

The three-spin coherence rephases to an ^{15}N -coherence during the delay T and becomes simultaneously labeled by the ^{15}N -chemical shift during the constant time-type of t_2 -evolution. Overlaying the rephasing and evolution delays minimizes transverse relaxation losses. Use of constant time evolution removes the relaxation decay of the magnetization of interest. So called „mirror image“ linear prediction can be used as the signal in the t_2 -dimension becomes a sum of undamped cosinusoidal oscillations of known phase ($=0^\circ$). A reverse INEPT transfer with sensitivity enhancement converts the coherences of interest back to the amide protons for observation.

Protons are decoupled by the DIPSI-2 scheme. Use of broadband decoupling prevents transverse ^{15}N -relaxation, giving further gain in sensitivity compared to the use of 180° -pulses. For reproducible water suppression it is essential to perform the decoupling in a synchronous mode. The ^{13}C -labeled carbonyl carbons are decoupled by a selective 180° -pulse during the $^{13}\text{C}^\alpha$ -evolution.

Data Acquisition**6.3****Sample:** 2 mM ^{15}N , ^{13}C -labeled Ribonuclease T1, (104 a.a.).**Experiment time:** 4h**Table 13: Acquisition Parameters**

Parameter	Value	Comments
PULPROG	hncagp3d	pulse program
NUC1	1H	nucleus on f1 channel
O1P	4.7 ppm	offset ^1H (optimize with „gs“)
NUC2	^{13}C	nucleus on f2 channel
O2P	54 ppm	offset ^{13}C (centered on C^α region)
NUC3	^{15}N	nucleus on f3 channel
O3P	116 ppm	offset ^{15}N
PL0	120 dB	power level preceding shaped pulse f2
PL1		high power level f1 channel
PL2	120 dB	high power level f2 channel (not used)
PL3		high power level f3 channel
PL16		power level for GARP decoupling (f3)
PL19		power level for DIPSI-2 decoupling (f1)
SP1		power level, selective H_2O flip-back, optimize in „gs“-mode!
SP2		power level, 90° shaped pulse (C^α on res.) f2
SP3		power level, 180° shaped pulse (C^α on res.) f2
SP5	=sp3	power level, 180° shaped pulse (C' off res.) f2
SP8	=sp2	power level, time reversed 90° (C^α on res.) f2
SPNAM1	Square.1000	selective H_2O flip-back
SPNAM2	Q5.256	90° shape: 4 Gaussian cascade
SPNAM3	Q3.256	180° shape: 3 Gaussian cascade
SPNAM5	Q3.256	180° shape: 3 Gaussian cascade
SPNAM8	Q5tr.256	90° , time reversed 4 Gaussian cascade
SPOFF1	0	selective H_2O flip-back
SPOFF2,3,8	0	on-resonance pulses
SPOFF5	preset	(^{13}C) in Hz (=176-54 ppm) cnst21-cnst22
CNST21	176	carbonyl carbon frequency
CNST22	54	alpha carbon frequency
P1		90° ^1H pulse f1 channel
P2	set to 2*p1	180° ^1H pulse f1 channel
P11	2000u	selective H_2O flip-back
P13	320u	90° selective pulse f2 (333u at 700MHz)

HNCA

Parameter	Value	Comments
P14	256u	180° selective pulse f2 channel
P16	1000u	gradient pulse length
P26	50 =pcpd1	90° DIPSI-2 pulse at pl19, proton
p21		90° ¹⁵ N pulse f3 channel
p22		180° ¹⁵ N pulse f3 channel
PCDP1	50	decoupling pulse DIPSI-2 channel f1
CPDPRG1	dipsi2	decoupling program channel f1
PCDP3		decoupling pulse GARP channel f3
CPDPRG3	garp	decoupling program channel f3
D1	1.0s	recycle delay
D16	100u	gradient recovery
GPZ1	30	#1 gradient amplitude
GPZ2	80	#2 gradient amplitude
GPZ3	8.1	#3 gradient amplitude
GNAM1	SINE.100	#1 gradient shape
GNAM2	SINE.100	#2 gradient shape
GNAM3	SINE.100	#3 gradient shape
NS	4	number of scans
DS	16	dummy scans (x*2*ns because of E/A)
RG	2k or more	receiver gain
F3 acquisition	*****	(leftmost column)
AQ_MOD	DQD	digital quadrature detection
TD	2048	number of points
SW	14 ppm	sweep width
NUCLEI	1H	
F2 indirect ¹⁵N	*****	(middle column)
FnMODE	echo-antiecho	XWIN-NMR 3.0 and onwards
TD	40	number of real points
SW	36 ppm	sweep width indirect ¹⁵ N
ND10	4	no of in10 in pulse program
NUCLEI	15N	
IN30	= IN10	Constant time: decrement equal to increment
F1 indirect ¹³C	*****	(rightmost column)
FnMODE	States-TPPI	XWIN-NMR 3.0 and onwards
TD	64	number of real points
SW	40 ppm	sweep width indirect ¹³ C
ND0	2	no of in0 in pulse program
NUCLEI	13C	

Adding ^2H decoupling

Deuteron decoupling in the aliphatic region is applied during the ^{13}C -evolution time t_1 when the magnetization is on the alpha carbons. The broadband ^1H -decoupling is interrupted during this time period. The proton-carbon couplings are refocused by a 180° ^1H -pulse, instead.

Table 14: ^2H decoupling parameters

Parameter	Value	Comments
PULPROG	hncagp2h3d	pulse program
NUC4	^2H	nucleus on f4 channel
O4P	3.0 ppm	offset ^2H (centered on aliphatic protons)
pl4	120 dB	power level for hard pulses f2 channel
pl17		power level for deuterium decoupling
cpdprg4	waltz16	decoupling program
pcpd4		decoupling pulse length ($\sim 300\mu\text{s}$)

Spectrum Processing

6.4

Table 15: Processing parameters

Parameter	Value	Comment
F3 acquisition	*****	(leftmost column)
SI	2k	zero fill to 2048 complex points
WDW	QSINE	squared sine bell window function, e.g.
SSB	3	shifting of the sine bell, $\pi/3=60^\circ$
PH_mod	no	phase correction applied
BC_mod	qpol	water deconvolution
BCFW	0.5-1.0	range for water deconvolution
F2 indirect ^{15}N	*****	(middle column)
SI	128	zero fill
MC2	echo-antiecho	
WDW	QSINE	squared sine bell window function
SSB	2	shifting of the sine bell, $\pi/3=60^\circ$
PH_mod	no	phase correction
F1 indirect ^{13}C	*****	(rightmost column)

HNCA

Parameter	Value	Comment
SI	256	zero fill
MC2	States-TPPI	
WDW	QSINE	squared sine bell window function
SSB	2	shifting of the sine bell, $\pi/3=60^\circ$
PH_mod	no	phase correction

Fig. 27. The ^1H - ^{13}C and ^1H - ^{15}N planes of the HNCA spectrum.

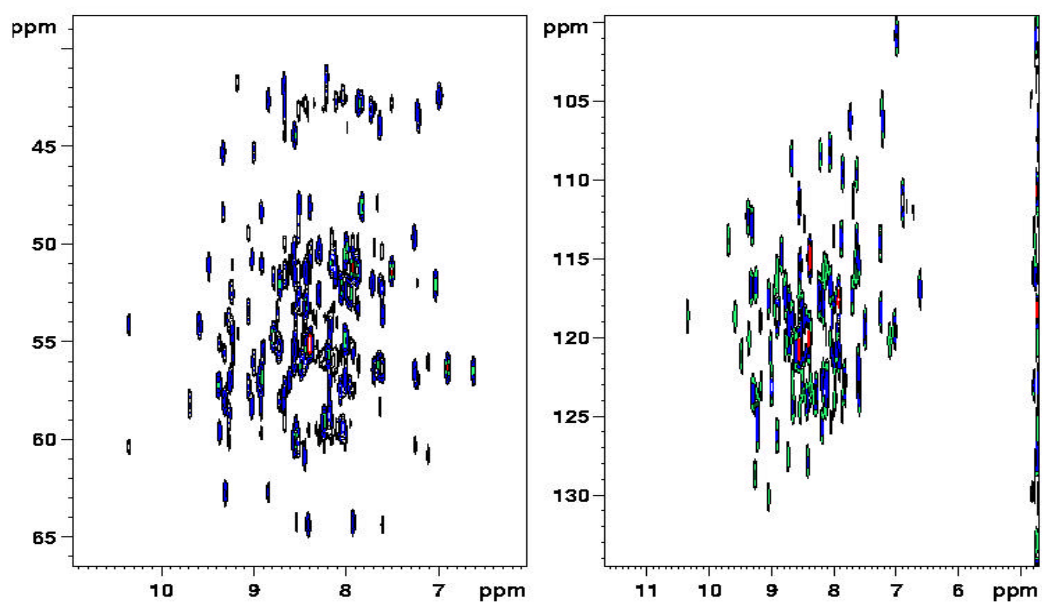

HN(CO)CA

7

Introduction

7.1

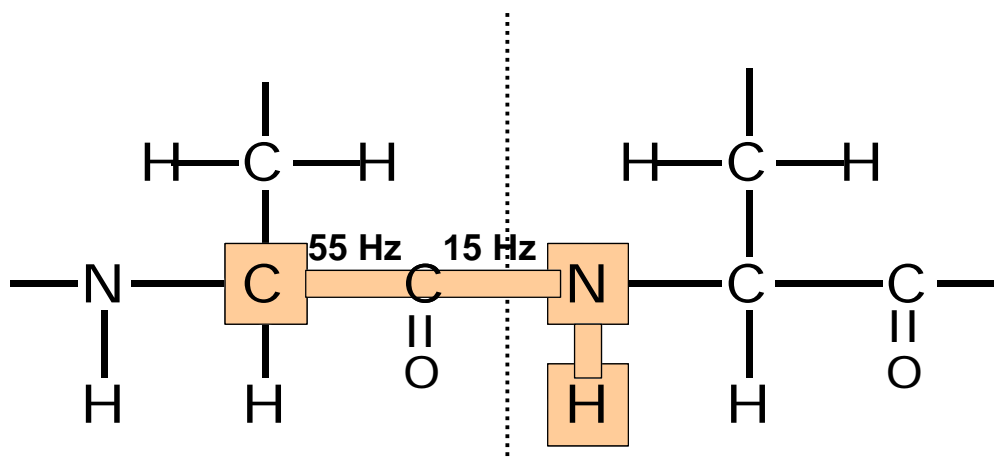
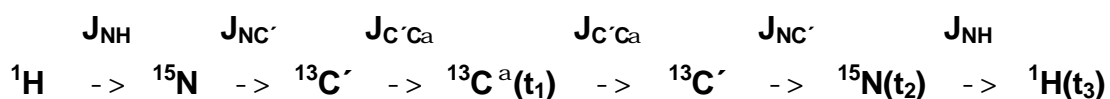

Fig. 28. Magnetization transfer in HN(CO)CA.

The HN(CO)CA experiment correlates the backbone amide proton and nitrogen (H^N_i and N_i) to the alpha-carbon of the preceding residue C^{α}_{i-1} . The magnetization transfer between the amide nitrogen and the alpha carbon takes place in two steps, via the intervening carbonyl carbon. The coupling constants are $J_{NC'} = 15$ Hz and $J_{C'C\alpha} = 55$ Hz. Particularly the latter is large, entailing shorter delays for the transfer at the time when the magnetization is on the fast relaxing heteronuclei. Thus the experiment can be used even at large line widths. Note that the second peak in HNCA originates from the direct transfer between the same nuclei due to the weaker two-bond coupling. HN(CO)CA consists of in total six coherence transfer steps:



Note that in both the HNCA and HN(CO)CA experiments the ${}^{13}\text{C}$ -evolution time $t_{1,\text{max}}$ should be kept shorter than $1/(2J_{\text{C}\alpha\text{C}\beta})$, in practice at around 10 ms, in order not to resolve this J-splitting of the signals in the carbon-13 dimension. Similarly, in order to avoid resolving the one-bond ${}^1J_{\text{NC}'}$ coupling in the ${}^{15}\text{N}$ dimension, the total time of transverse ${}^{15}\text{N}$ magnetization ($t_{2,\text{max}} + 2\delta + 2T$) should be kept smaller than $1/J_{\text{NC}'}$. To facilitate the analysis of the HNCA and HN(CO)CA spectra the values for the sweep widths and offset in these two experiments should be identical.

References:

An efficient 3D NMR technique for correlating the proton and ${}^{15}\text{N}$ backbone amide resonances with the α -carbon of the preceding residue in uniformly ${}^{15}\text{N}/{}^{13}\text{C}$ enriched proteins. A. Bax, M. Ikura. J.Biomol. NMR. 1 (1991) 99-104.

Pulse Sequence Diagram

7.2

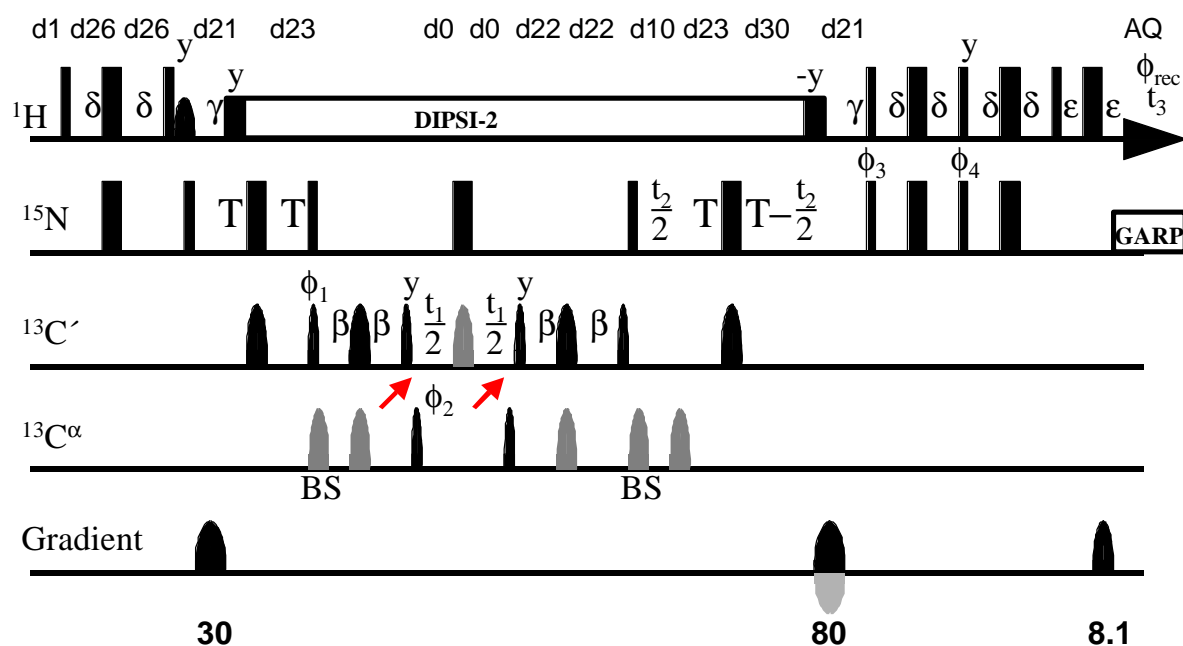

Fig. 29. HN(CO)CA.

	$\phi_2 = x, -x + \text{States-TPPI } (t_1)$	$\phi_3 = x, x, -x, -x$
$\phi_4 = -y, -y, y, y + \text{echo-antiecho}(t_2)$	$\phi_{\text{rec}} = x, -x, -x, x$	$\phi_1 = x, -x$
$\delta = 2.3 \text{ ms}$	$\beta = 4.0 \text{ ms}$	$\gamma = 5.5 \text{ ms}$
$T = 12.0 \text{ ms}$	$\varepsilon = \text{gradient} + \text{recovery}$	

Above the arrows indicate the points of shifting the ^{13}C offset and the striped pulses are off-resonance. All carbon pulses are selective.

The sequence starts with an INEPT transfer of the magnetization from the backbone ^1H to the ^{15}N . This is followed by a delay T , during which the antiphase term is refocused and simultaneously the 1-bond coupling between ^{15}N and carbonyl- ^{13}C creates an antiphase coherence $N_y C'_z$. It is converted to $N_z C'_y$ by the pair of ^{13}C and ^{15}N 90° -pulses, and subsequently correlated with the $^{13}\text{C}^\alpha$ spins in an INEPT-transfer during the delays β , relying on the 1-bond coupling between the carbonyl and alpha carbons. The coherence is labeled by the $^{13}\text{C}^\alpha$ chemical shift during the t_1 -evolution time, and subsequently converted back to $N_y C'_z$. This rephases to an ^{15}N -coherence during the delay T and becomes simultaneously labeled by the ^{15}N -chemical shift during the constant time-type of t_2 -evolution. Overlaying of the rephasing and evolution delays minimizes transverse relaxation losses. A reverse INEPT transfer with sensitivity enhancement converts the coherence of interest back to the amide protons for observation.

Protons are decoupled by broadband DIPSI-2 scheme as in the HNCA experiment. The ^{13}C -labeled carbonyl carbons are decoupled by a selective 180° -pulse during the $^{13}\text{C}^\alpha$ -evolution. The ^{13}C -labeled carbonyl and alpha carbons are decoupled by selective 180° -pulses during the ^{15}N -CT-evolution.

Sample: 2 mM ^{15}N , ^{13}C -labeled Ribonuclease T1, (104 a.a.).

Experiment time: 4h

Table 16: Acquisition Parameters

Parameter	Value	Comments
PULPROG	hncocagp3d	pulse program
NUC1	^1H	nucleus on f1 channel
O1P	4.7 ppm	offset ^1H (optimize with „gs“)
NUC2	^{13}C	nucleus on f2 channel
O2P	54 ppm	offset ^{13}C (centered on C^α region)
NUC3	^{15}N	nucleus on f3 channel
O3P	116 ppm	offset ^{15}N
PL0	120 dB	power level preceding shaped pulse f2
PL1		high power level f1 channel
PL2	120 dB	high power level f2 channel (not used)
PL3		high power level f3 channel
PL16		power level for GARP decoupling, f3 channel
PL19		power level for DIPSI-2 decoupling f1 channel
SP1		power level, selective H_2O flip-back optimize in „gs“-mode!
SP2		power level, 90° shaped pulse (on res.) f2
SP3		power level, 180° shaped pulse (on res.) f2
SP5	=sp3	power level, 180° shaped pulse (C^α off res.) f2
SP7	=sp3	power level, 180° shaped pulse (C' off res.) f2
SP8	=sp2	power level, time reversed 90° (on res.) f2
SPNAM1	Square.1000	selective H_2O flip-back
SPNAM2	Q5.256	90° shape: 4 Gaussian cascade
SPNAM3	Q3.256	180° shape: 3 Gaussian cascade
SPNAM5	Q3.256	180° shape: 3 Gaussian cascade
SPNAM7	Q3.256	180° shape: 3 Gaussian cascade
SPNAM8	Q5tr.256	90° shape: time reversed 4 Gaussian cascade
SPOFF1	0	selective H_2O flip-back offset
SPOFF2,3,8	0	on-resonance pulses
SPOFF5	preset	(^{13}C) in Hz (=176-54 ppm) cnst21-cnst22
SPOFF7	preset	(^{13}C) in Hz (=54-176ppm) cnst22-cnst21

Parameter	Value	Comments
CNST21	176	carbonyl carbon frequency
CNST22	54	alpha carbon frequency
P1	preset to 2*p3	90° ¹ H pulse f1 channel
P2	set to 2*p2	180° ¹ H pulse f1 channel
P11	1000-2000u	selective H ₂ O flip-back if needed!
P13	320u	90° selective pulse f2 (333μs on 700MHz)
P14	256u	180° selective pulse f2
P16	1000u	gradient pulse length
P26	50 =pcpd1	90° DIPSI-2 trim pulse at pl19
P21		90° ¹⁵ N pulse f3 channel
P22	set to 2*p21	180° ¹⁵ N pulse f3 channel
PCDP1	50	decoupling pulse DIPSI-2 channel f1 (¹ H)
CPDPRG1	dipsi2	decoupling program channel f1 (¹ H)
PCDP3		decoupling pulse GARP channel f3 (¹⁵ N)
CPDPRG3	garp	decoupling program channel f3 (¹⁵ N)
D1	1.0s	recycle delay
D16	100u	gradient recovery
GPZ1	30	#1 gradient amplitude
GPZ2	80	#2 gradient amplitude
GPZ3	8.1	#3 gradient amplitude
GNAM1	SINE.100	#1 gradient shape
GNAM2	SINE.100	#2 gradient shape
GNAM3	SINE.100	#3 gradient shape
NS	4	number of scans
DS	16	dummy scans (x*2*ns because of E/A)
RG	1k or more	receiver gain
F3 acquisition	*****	(leftmost column)
AQ_MOD	DQD	digital quadrature detection
TD	2048	number of points
SW	14 ppm	sweep width
NUCLEI	¹ H	
F2 indirect ¹⁵N	*****	(middle column)
FnMODE	echo-antiecho	XWIN-NMR 3.0 and onwards
TD	40	number of real points
SW	36 ppm	sweep width indirect ¹⁵ N
ND10	4	no of in10 in pulse program
NUCLEI	¹⁵ N	
IN30	= IN10	constant time: increment = decrement

Parameter	Value	Comments
F1 indirect ^{13}C	*****	<i>(rightmost column)</i>
FnMODE	States-TPPI	XWIN-NMR 3.0 and onwards
TD	64	number of real points
SW	40 ppm	sweep width indirect ^{13}C
ND0	2	no of in0 in pulse program
NUCLEI	^{13}C	

Creating the ^{13}C frequency list

Up to XWINNMR 3.5 the frequencies of the shaped pulses could not be given through constants in ppm. Instead, so called frequency lists had to be prepared. This is done in the following way.

In this experiment the ^{13}C frequency is initially at the carbonyl-carbon frequency of 173 ppm. When the magnetization has been transfer from $^{13}\text{C}'$ to $^{13}\text{C}^\alpha$ the frequency is changed to the value of 52 ppm in the middle of the alpha-carbon region. For this purpose you need to create the frequency list. Edit a file /u/exp/stan/nmr/lists/f1/hncoca13c with the following contents:

```
P
173.0
52.0
```

Up to XWINNMR Version 3.1 the frequency lists could not be given in ppm, but had to be given in Hz in the following way:

```
O 150.902749
26108.18
8008.18
```

The first line contains the capital letter „O“ and the basic frequency of ^{13}C on your instrument (bf2). The second line is the carbonyl offset in Hz (given by the o2 parameter). The third line corresponds to the alpha-carbon offset used for the spo5, in the above example 26108.18-18100=8008.18 Hz. Note that in this case the o2p value only sets the frequency in the spectral display.

Spectrum Processing

7.4

Table 17: Processing parameters

Parameter	Value	Comment
F3 acquisition	*****	<i>(leftmost column)</i>
SI	2k	zero fill to 2048 complex points
WDW	QSINE	squared sine bell window function, e.g.
SSB	3	shifting of the sine bell, $\pi/3=60^\circ$

HN(CO)CA

Parameter	Value	Comment
PH_mod	pk	phase correction applied
PHC0		zero order phase correction
PHC1		first order phase correction
BC_mod	qpol	water deconvolution
BCFW	0.5-1.0	range for water deconvolution, in ppm
F2 indirect ¹⁵N	*****	(middle column)
SI	128	zero fill
MC2	echo-antiecho	
WDW	QSINE	squared sine bell window function
SSB	2	shifting of the sine bell, $\pi/3=60^\circ$
PH_mod	no	phase correction
REVERSE	TRUE	
F1 indirect ¹³C	*****	(rightmost column)
SI	256	zero fill
MC2	States-TPPI	
WDW	QSINE	squared sine bell window function
SSB	2	shifting of the sine bell, $\pi/3=60^\circ$
PH_mod	pk	phase correction
PHC0		zero order phase correction
PHC1		first order phase correction

Fig. 30. The ¹H-¹³C and ¹H-¹⁵N planes of the HN(CO)CA spectrum.

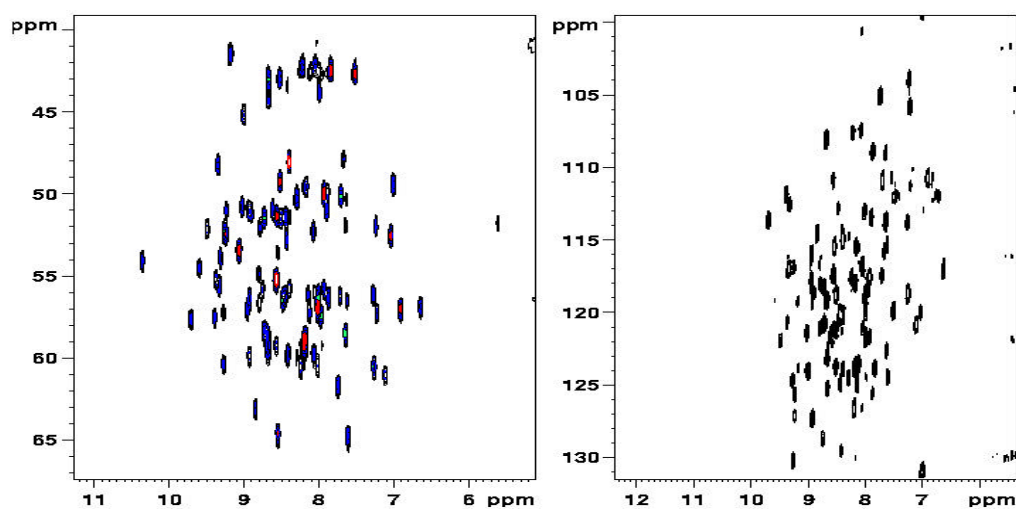

CBCA(CO)NH

8

Introduction

8.1

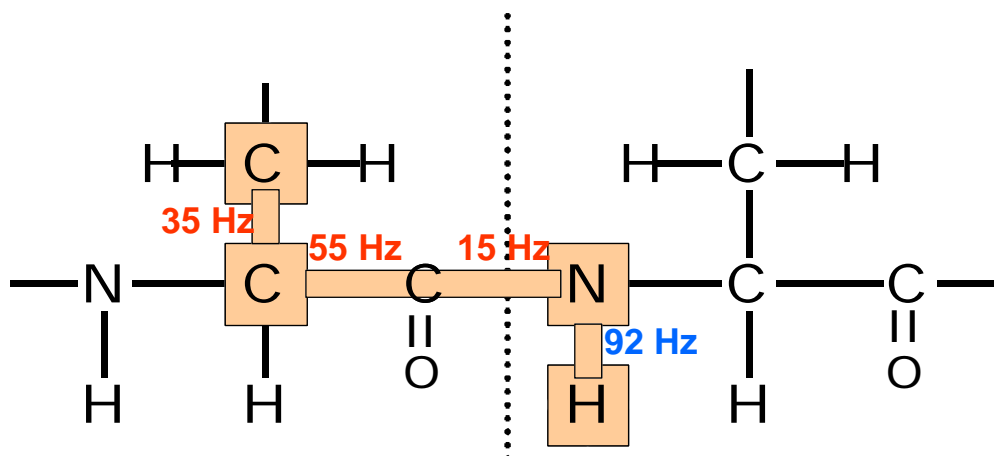
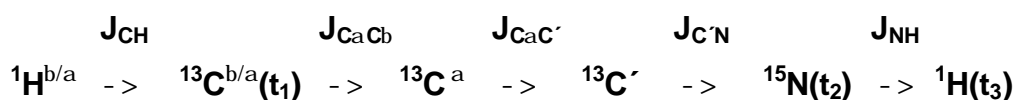

Fig. 31. The magnetization transfer in CBCA(CO)NH.

The CBCA(CO)NH experiment correlates the backbone amide proton and nitrogen frequencies of one residue with the alpha- and beta-carbon frequencies of the preceding residue. Thus the spectrum contains the same information as HN(CO)CA. The CBCA(CO)NH experiment is less sensitive, but provides in addition the $^{13}\text{C}^{\beta}$ frequencies which are instrumental for identification of residue type and secondary structure, and correlation of side chains to the sequential assignment. The flow of the magnetization is following



References:

Gradient-enhanced triple-resonance three-dimensional NMR experiments with improved sensitivity. D. R. Muhandiram, L. E. Kay. J. Magn. Res. B 103 (1994) 203-216.

Correlating backbone amide and side chain resonances in larger proteins by multiple relayed triple resonance NMR. S. Grzesiek, A. Bax. J. Am. Chem. Soc. 114 (1992) 6291-6293.

Pulse Sequence Diagram

8.2

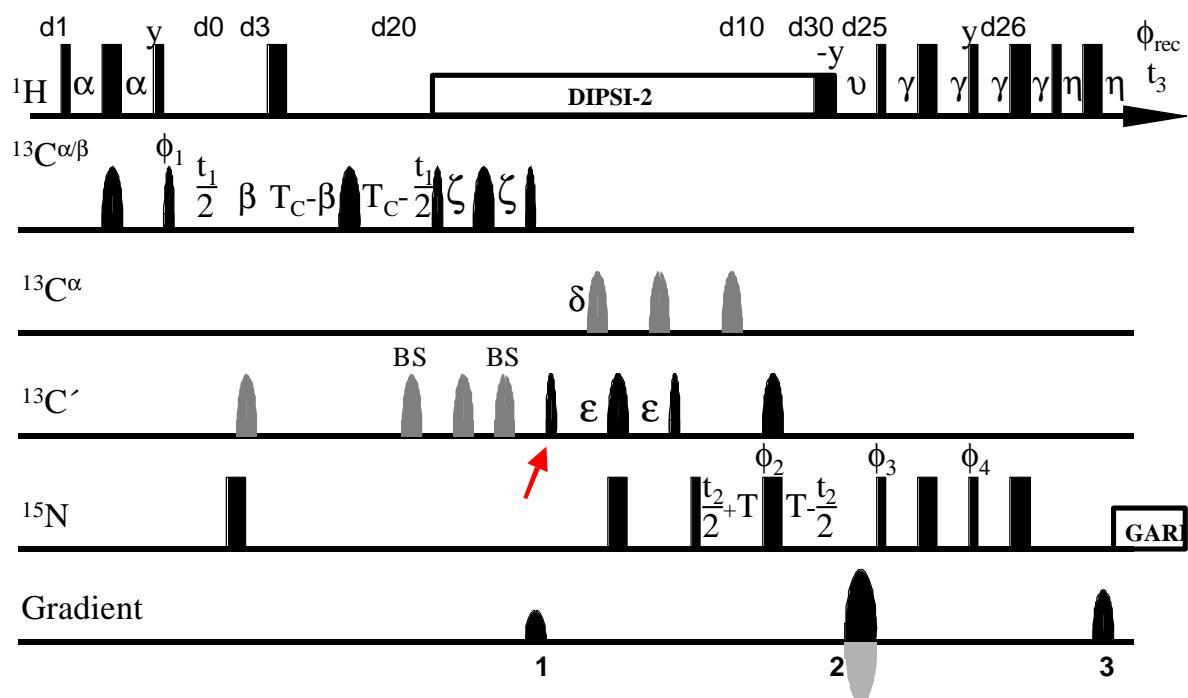

$\phi_1 = x, -x + \text{States-TPPI } (t_1)$	$\phi_3 = 2x, 2(-x)$	$\phi_4 = 2(y), 2(-y)$
$\phi_2 = -4x, 4(-x) + \text{echo-antiecho}(t_2)$	$\phi_{\text{rec}} = 2(x, -x, -x, x)$	
$\alpha = 1.7 \text{ ms}$	$\beta = 1.1 \text{ ms}$	$\zeta = 3.6 \text{ ms}$
$\epsilon = 12.4 \text{ ms}$	$\nu = 5.5 \text{ ms}$	$\delta = 4.4 \text{ ms}$
$T_C = 3.6 \text{ ms}$	$T = 12.4 \text{ ms}$	$\gamma = 2.3 \text{ ms}$
		$\eta = \text{gradient} + \text{recovery}$
		arrow = ^{13}C -frequency moves from C^α to C'

Fig. 32. CBCA(CO)NH.

The sequence starts with an INEPT enhancement of the magnetization of the aliphatic carbons. The ^{13}C magnetization undergoes chemical shift t_1 -evolution during the constant time period $2 \cdot T_C$ (in order to avoid line broadening due to ^{13}C - ^{13}C couplings). The total length of the constant time is $\sim 1/(4J_{CC}) = 7.2 \text{ ms}$. Scalar coupling to the carbonyls is removed by a selective 180° pulse. Note that the carbonyl 180° pulses denoted by BS are applied in order to remove the phase shifts caused by the preceding 180° -pulse. The third 90° carbon pulse converts $^{13}\text{C}^\beta$ magnetization to $^{13}\text{C}^\alpha$ magnetization. The existing $^{13}\text{C}^\alpha$ magnetization is not affected. During the subsequent delay of 2ζ the $^{13}\text{C}^\alpha$ -magnetization is conferred to the carbonyls. During the delay δ the carbonyl magnetization refocuses with respect to its attached $^{13}\text{C}^\alpha$ spin, and during the delay 2ϵ it is transferred to the adjacent ^{15}N spin. During the second constant time period $2 \cdot T_N$ ($= 24.8 \text{ ms}$) the antiphase ^{15}N magnetization rephases with respect to the carbonyl and becomes labeled by the ^{15}N -chemical shift. The ^{15}N -magnetization dephases with respect to the attached proton during the final fraction ν , when ^1H decoupling is turned off. At the end the magnetization is transferred to the observable proton coherences through a sensitivity enhanced reverse INEPT sequence. Coherent ^1H decoupling is interrupted during the gradients.

Sample: 2 mM ^{15}N , ^{13}C -labeled Ribonuclease T1, (104 a.a.).

Experiment time: 7.5h

Table 18: Acquisition Parameters

Parameter	Value	Comments
PULPROG	cbcaconhgp3d	pulse program
NUC1	^1H	nucleus on f1 channel
O1P	4.7 ppm	offset ^1H (optimize with „gs“)
NUC2	^{13}C	nucleus on f2 channel
O2P	39 ppm	offset ^{13}C (centered on $\text{C}^\alpha/\text{C}^\beta$ region)
NUC3	^{15}N	nucleus on f3 channel
O3P	116 ppm	offset ^{15}N
PL0	120 dB	power level preceding shaped pulse f2
PL1		high power level f1 channel
PL2	120 dB	high power level f2 channel (not used)
PL3		high power level f3 channel
PL16		power level for GARP decoupling f3 channel
PL19		power level for DIPSI-2 decoupling ^1H
SP2		power level, 90° shaped pulse (^{13}C on res.)
SP3		power level, 180° shaped pulse (^{13}C on res.)
SP5	=sp3	power level, 180° shaped pulse (C' off res.)
SP7	=sp3	power level, 180° shaped pulse (C^α off res.)
SP8	=sp2	power level, time reversed 90° (^{13}C on res.)
SPNAM2	Q5.256	90° shape: 4 Gaussian cascade
SPNAM3	Q3.256	180° shape: 3 Gaussian cascade
SPNAM5	Q3.256	180° shape: 3 Gaussian cascade
SPNAM7	Q3.256	180° shape: 3 Gaussian cascade
SPNAM8	Q5tr.256	90° shape: time reversed 4 Gaussian casc.
SPOFF2,3,8	0 preset	
SPOFF5	preset	(^{13}C) in Hz (176-39 ppm) cnst21-cnst23
SPOFF7	preset	(^{13}C) in Hz (54-176 ppm) cnst22-cnst21
CNST21	176	carbonyl frequency
CNST22	54	alpha-carbon frequency
CNST23	39	aliphatic carbon frequency
P1		90° ^1H pulse f1 channel
P2	set to 2*p1	180° ^1H pulse f1 channel

CBCA(CO)NH

Parameter	Value	Comments
P13	320u	90° selective pulse f2 (333µs at 700 MHz)
P14	256u	180° selective pulse f2
P16	1000u	#1 gradient pulse length
P21		90° ¹⁵ N pulse f3 channel
P22	set to 2*p21	180° ¹⁵ N pulse f3 channel
P26	50u	trim pulse DIPSI-2 channel f1
PCDP1	50u	decoupling pulse length DIPSI-2 channel f1
CPDPRG1	dipsi2	decoupling program channel f1
PCDP3		decoupling pulse length GARP channel f3
CPDPRG3	garp	decoupling program channel f3
D1	1.0 s	recycle delay
D16	100u	gradient recovery
GPZ1	30	#1 gradient amplitude
GPZ2	80	#2 gradient amplitude
GPZ3	8.1	#3 gradient amplitude
GNAM1...3	SINE.100	#1 gradient shape
NS	8	number of scans
DS	32	dummy scans (x*2*ns because of E/A)
FQ2LIST1	cbcaconh13c	see the instruction below
F3 acquisition	*****	(leftmost column)
AQ_MOD	DQD	digital quadrature detection
TD	2048	number of points
SW	14 ppm	sweep width
NUCLEI	¹ H	
F2 indirect ¹⁵N	*****	(middle column)
FnMODE	echo-antiecho	XWIN-NMR 3.0 and onwards
TD	36	number of real points
SW	36 ppm	sweep width indirect ¹⁵ N
ND10	4	no of in10 in pulse program
NUCLEI	¹⁵ N	
IN30	= IN10	constant time: decrement should be equal to increment
F1 indirect ¹³C	*****	(rightmost column)
FnMODE	States-TPPI	XWIN-NMR 3.0 and onwards
TD	128	number of real points
SW	75 ppm	sweep width indirect ¹³ C
ND0	2	no of in0 in pulse program
NUCLEI	¹³ C	

Table 19: Processing parameters

Parameter	Value	Comment
F3 acquisition	*****	(leftmost column)
SI	2k	zero fill to 4096 complex points
WDW	QSINE	squared sine bell window function, e. g.
SSB	3	shifting of the sine bell, $\pi/3=60^\circ$
PH_mod	pk	phase correction applied
PHC0		zero order phase correction
PHC1		first order phase correction
BC_mod	qpol	Removal of water residual water signal
BCFW	1.0	+/- ppm around water is deconvoluted
STSR	0	Display only the left half of spectrum
STSI	1k	- „ -
F2 indirect ^{15}N	*****	(middle column)
SI	256	zero fill
MC2	echo-antiecho	
WDW	QSINE	squared sine bell window function
SSB	3	shifting of the sine bell, $\pi/3=60^\circ$
PH_mod	no	phase correction
F1 indirect ^{13}C	*****	(rightmost column)
SI	1k	zero fill
MC2	States-TPPI	
WDW	QSINE	squared sine bell window function
SSB	3	shifting of the sine bell, $\pi/3=60^\circ$
PH_mod	no	phase correction not needed

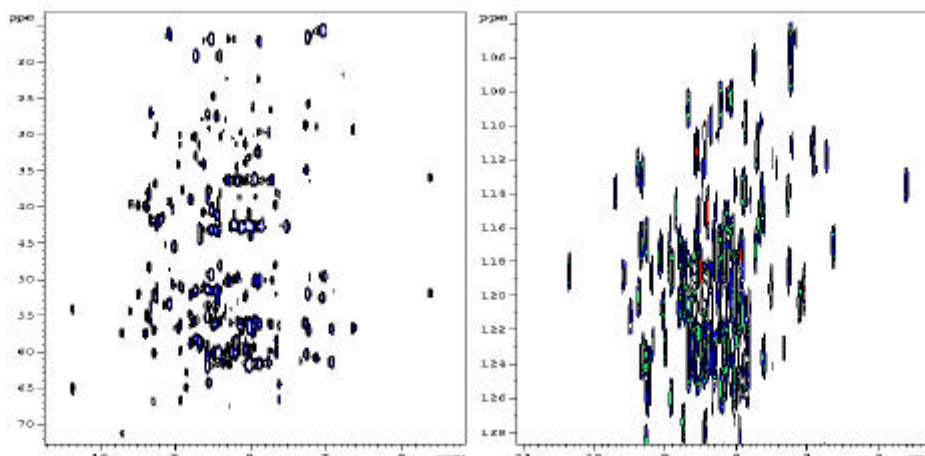
Fig. 33. The ^1H - ^{13}C and ^1H - ^{15}N planes of the CBCA(CO)NH spectrum.

HBHA(CO)NH

9

Introduction

9.1

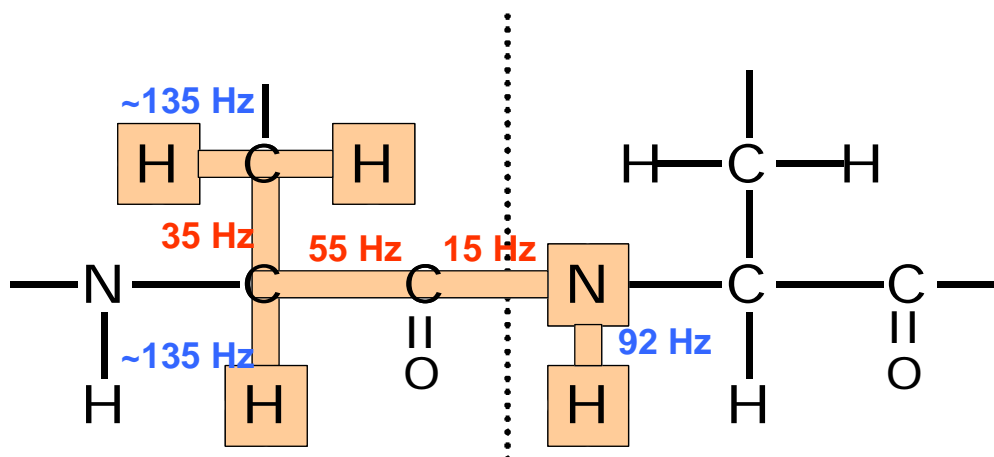
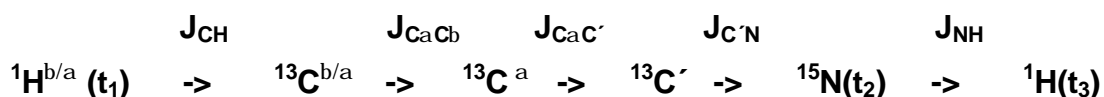

Fig. 34. The magnetization transfer in HBHA(CO)NH.

The HAHB(CO)NH experiment correlates the backbone amide proton and nitrogen frequencies of one residue with the alpha- and beta-proton frequencies of the preceding residue. Thus it is similar to the CBCA(CO)NH experiment and it is also equally sensitive. The flow of the magnetization is the following



References:

An efficient triple-resonance experiment for proton-directed sequential backbone assignment of medium-sized proteins. A. C. Wang, P. J. Lodi, J. Qin, G. W. Vuister, A. M. Gronenborn, G. M. Clore. *J. Magn. Res. B* 105 (1994) 196-198.

Amino acid type determination in the sequential assignment procedure of uniformly ¹³C/¹⁵N-enriched proteins. S. Grzesiek, A. Bax. *J. Biomol. NMR* 3 (1993) 185-204.

Pulse Sequence Diagram

9.2

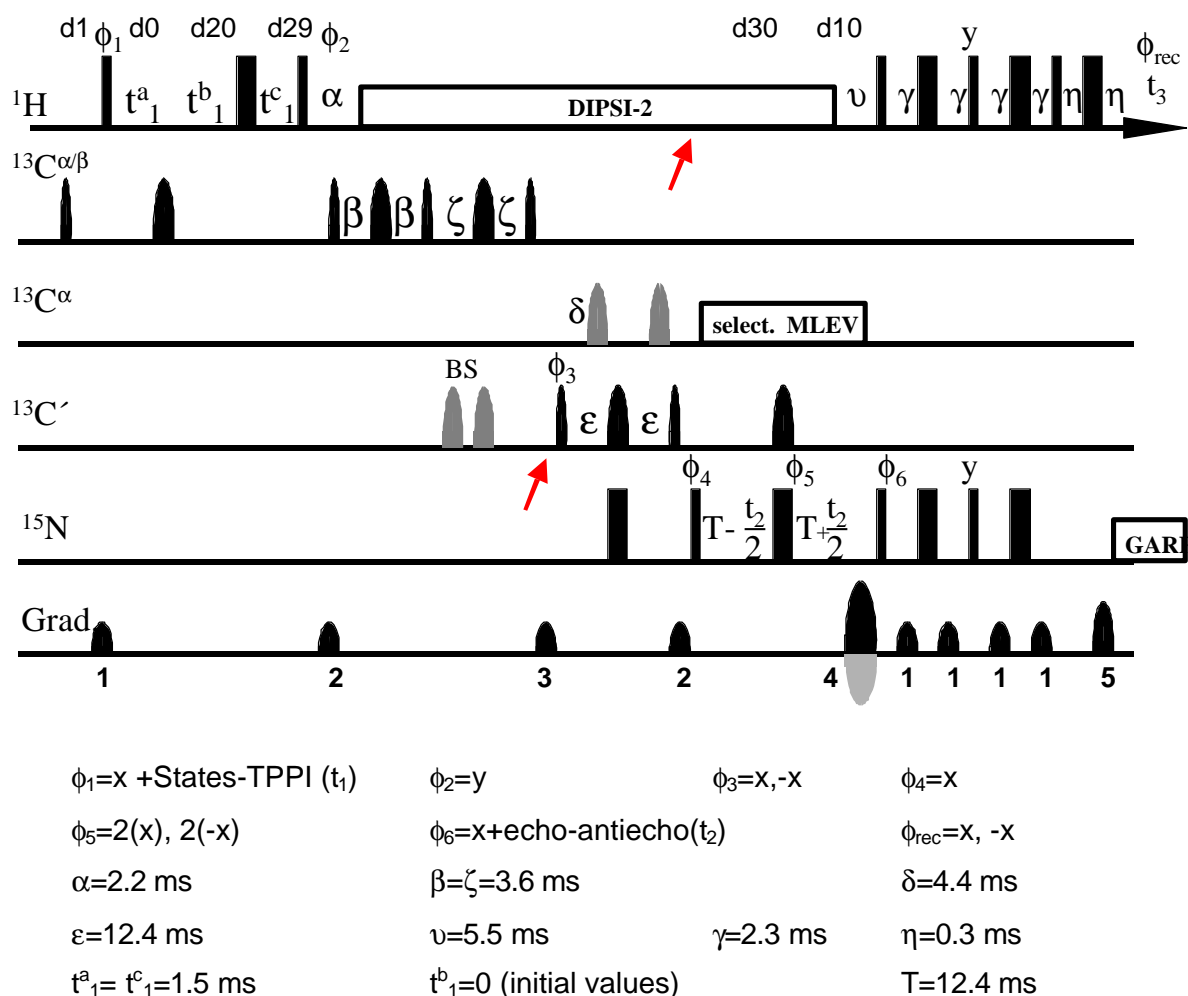

Fig. 35. HBHA(CO)NH.

The arrow indicates where the ^{13}C -frequency is moved from C^α to C' and the ^1H -offset from aliphatics to the amide region or water frequency.

The carbonyl 180° -pulse denoted by BS compensates for the phase shift caused by the preceding 180° -pulse. Striped pulses are off-resonance.

The sequence starts with proton magnetization that is labeled by the ^1H -chemical shift labeled during a semi-constant time evolution period. Simultaneously the magnetization becomes antiphase with respect to the attached $^{13}\text{C}^\alpha$ and $^{13}\text{C}^\beta$. It is refocused during delay α . Transfer from $^{13}\text{C}^\beta$ to $^{13}\text{C}^\alpha$ takes place during the delay 2β . From here on the sequence is identical to the CBCA(CO)NH experiment.

Data Acquisition**9.3****Sample:** 1 mM ^{15}N , ^{13}C -labeled Ribonuclease T1, (104 a.a.).**Experiment time:** 19h**Table 20: Acquisition Parameters**

Parameter	Value	Comments
PULPROG	hbhaconhgp3d	pulse program
NUC1	^1H	nucleus on f1 channel
O1P	4.7 ppm	offset ^1H (or 3.0 ppm, see note below)
NUC2	^{13}C	nucleus on f2 channel
O2P	43 ppm	offset ^{13}C (centered on $\text{C}^\alpha/\text{C}^\beta$ region)
NUC3	^{15}N	nucleus on f3 channel
O3P	116 ppm	offset ^{15}N
PL0	120 dB	power level preceding shaped pulse f2
PL1		high power level f1 channel
PL2	120 dB	high power level f2 channel (not used)
PL3		high power level f3 channel
PL16		power level for GARP decoupling f3 channel
PL19		power level for DIPSI-2 decoupling f1
SP2		power level, 90° shaped pulse (C^α on res.) f2
SP3		power level, 180° shaped pulse (C^α on res.)
SP5	=sp3	power level, 180° shaped pulse (C' off res.)
SP7	=sp3	power level, 180° shaped pulse (C^α off res.)
SP8	=sp2	power level, time reversed 90° (C^α on res.)
SPNAM2	Q5.256	90° shape: 4 Gaussian cascade
SPNAM3	Q3.256	180° shape: 3 Gaussian cascade
SPNAM5	Q3.256	180° shape: 3 Gaussian cascade
SPNAM7	Q3.256	180° shape: 3 Gaussian cascade
SPNAM8	Q5tr.256	90° shape: time reversed 4 Gaussian casc.
SPOFF2, 3, 8	0 preset	
SPOFF5	preset	(^{13}C) in Hz (176-39 ppm) cnst21-cnst23
SPOFF7	preset	(^{13}C) in Hz (54-176 ppm) cnst22-cnst21
CNST21	176	carbonyl frequency
CNST22	54	alpha-carbon frequency
CNST23	39	aliphatic carbon frequency
P1		90° ^1H pulse f1 channel
P2	set to 2*p1	180° ^1H pulse f1 channel
P13	320u	90° selective pulse f2
P14	256u	180° selective pulse f2

HBHA(CO)NH

Parameter	Value	Comments
P16	1000u	#1 gradient pulse length
P21		90° ¹⁵ N pulse f3 channel
P22		180° ¹⁵ N pulse f3 channel
P26	50	same as pcpd1 (trim pulse for dipsi-2)
PCDP1	50	decoupling pulse length DIPSI-2 channel f1
CPDPRG1	dipsi2	decoupling program channel f1
PCDP3		decoupling pulse length GARP channel f3
CPDPRG3	garp	decoupling program channel f3
D1	1.5 s	recycle delay
D16	100u	gradient recovery
GPZ1	30	#1 gradient amplitude
GPZ2	80	#2 gradient amplitude
GPZ3	8.1	#3 gradient amplitude
GPNAM1	SINE.100	#1 gradient shape
GPNAM2	SINE.100	#2 gradient shape
GPNAM3	SINE.100	#3 gradient shape
NS	16	number of scans
DS	32	dummy scans (x*2*ns because of E/A)
F3 acquisition	*****	(leftmost column)
AQ_MOD	DQD	digital quadrature detection
TD	2048	number of points
SW	14 ppm	sweep width
NUCLEI	¹ H	
F2 indirect ¹⁵N	*****	(middle column)
FnMODE	echo-antiecho	
TD	36	number of real points
SW	35 ppm	sweep width indirect ¹⁵ N
ND10	4	no of in10 in pulse program
NUCLEI	¹⁵ N	
IN30	= IN10	Constant time: size of the increment and decrement should be equal
F1 indirect ¹H	*****	(rightmost column)
FnMODE	States-TPPI	
TD	256	number of real points
SW	7 ppm	sweep width indirect ¹ H; half of sw(F3)
ND0	2	no of in0 in pulse program
NUCLEI	¹ H	

Table 21: Processing parameters

Parameter	Value	Comment
F3 acquisition		<i>(leftmost column)</i>
SI	2k	zero fill to 2048 complex points
WDW	QSINE	squared sine bell window function, e.g.
SSB	3	shifting of the sine bell, $\pi/3=60^\circ$
PH_mod	pk	phase correction applied
PHC0		zero order phase correction
PHC1		first order phase correction
BC_mod	no	no automatic baseline correction
F2 indirect ^{15}N	*****	<i>(middle column)</i>
SI	256	zero fill
MC2	echo-antiecho	
WDW	QSINE	squared sine bell window function
SSB	3	shifting of the sine bell, $\pi/3=60^\circ$
PH_mod	pk	phase correction
PH_mod	no	Phase correction not needed
F1 indirect ^{13}C	*****	<i>(rightmost column)</i>
SI	1k	zero fill
MC2	States-TPPI	
WDW	QSINE	squared sine bell window function
SSB	3	shifting of the sine bell, $\pi/3=60^\circ$
PH_mod	no	phase correction not needed
SR	$\frac{1}{4}$ swH(F1)	set to $\frac{1}{4}$ * of swH(F1) for correct scale

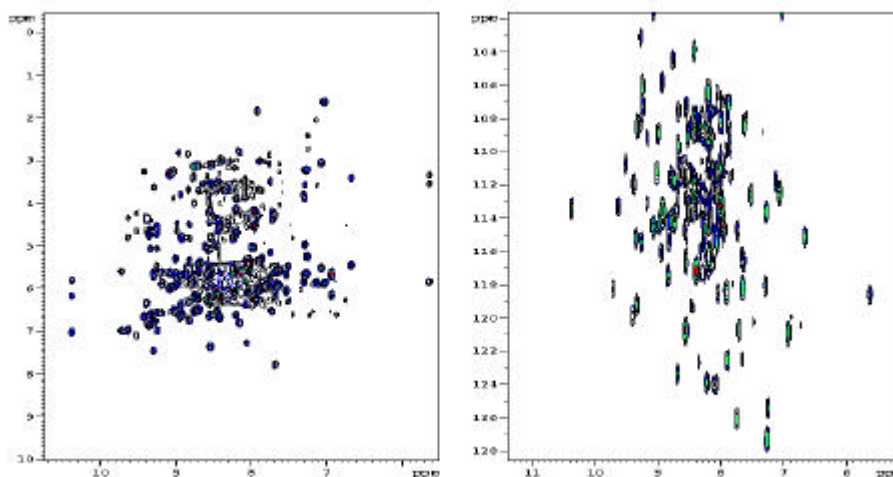
Fig. 36. The ^1H - ^1H and ^1H - ^{15}N planes of the HBHA(CO)NH spectrum.

H(CC)(CO)NH

10

Introduction

10.1

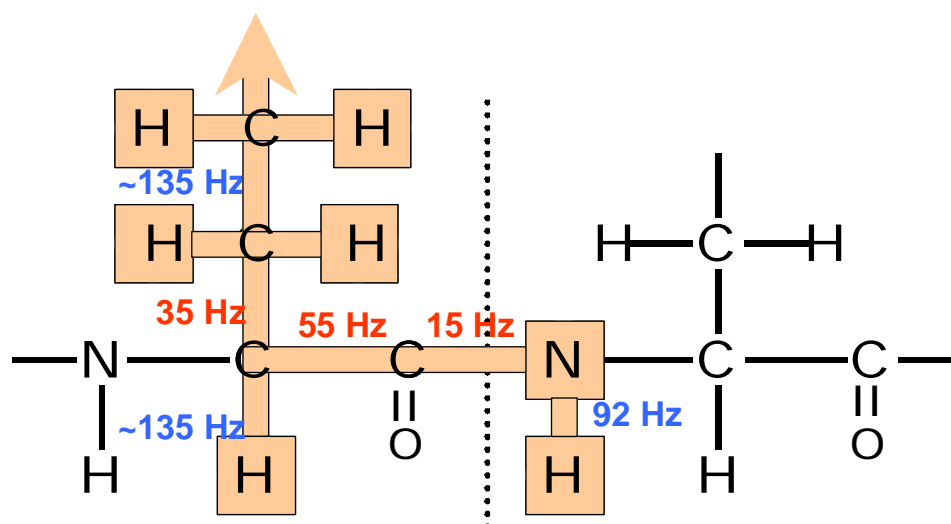
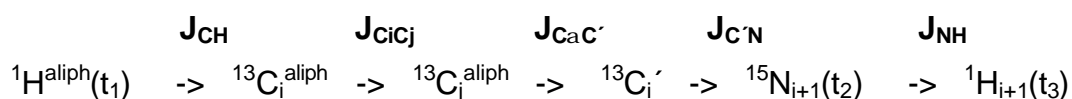

Fig. 37. The magnetization transfer in H(CC)(CO)NH.

The H(CC)(CO)NH experiment correlates the backbone amide proton and nitrogen frequencies of one residue with the side chain proton frequencies of the preceding residue. Thus the spectral layout is similar to the ^{15}N -TOCSY experiment and it can be conveniently analyzed together with the ^{15}N -NOESY HSQC and HAHB(CO)NH experiments. The experimental sensitivity is, however, lower. The flow of the magnetization is the following



References:

Heteronuclear multidimensional NMR experiments for the structure determination of proteins in solution employing pulsed field gradients. M. Sattler, J. Schleucher & C. Griesinger. Prog. NMR Spectr. 34 (1999) 93-158.

Correlation of Backbone amide and aliphatic side-chain resonances in $^{13}\text{C}/^{15}\text{N}$ -enriched proteins by isotropic mixing of ^{13}C magnetization. S. Grzesiek, J. Anglister, A. Bax. J. Magn. Res. B 101 (1993) 114-119.

Pulse Sequence Diagram

10.2

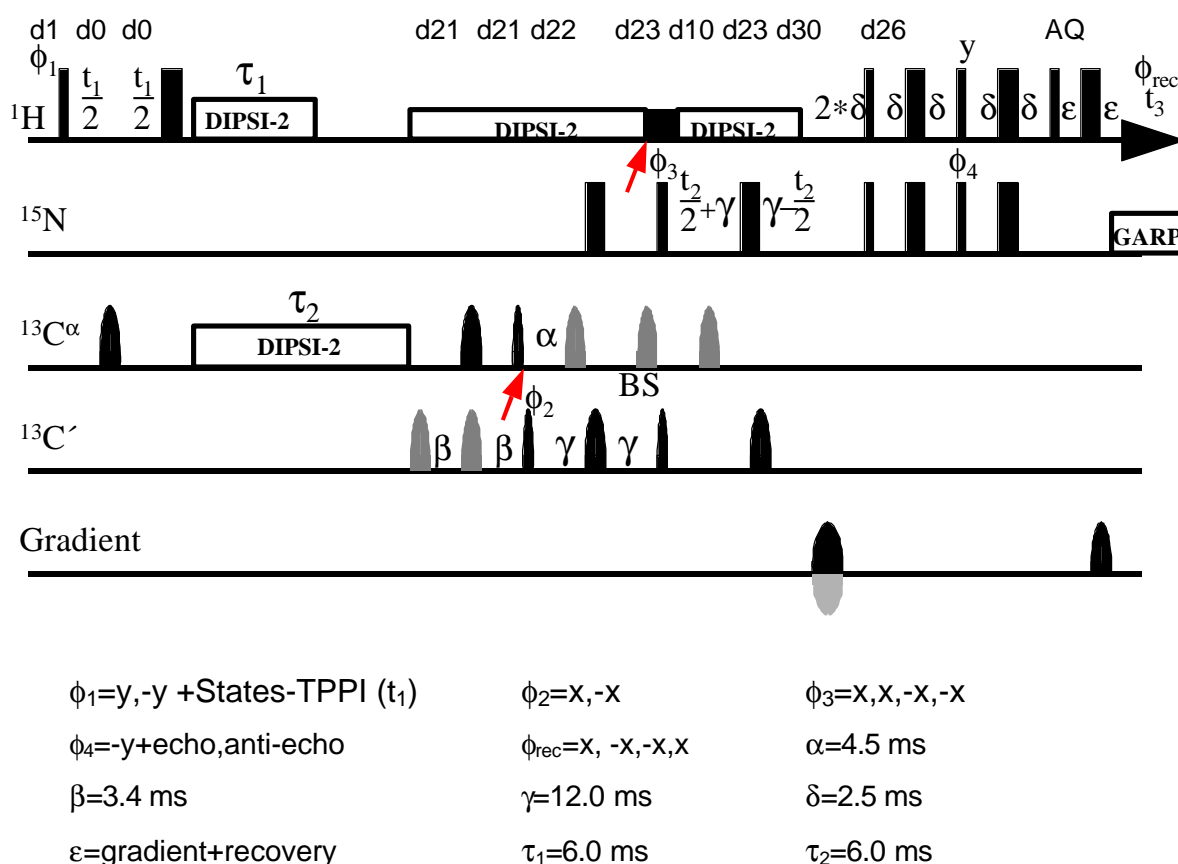

Fig. 38. H(CC)(CO)NH.

The arrows indicates where the ^{13}C -frequency is moved from C^α to C' and the ^1H -offset from the water frequency to the amide region. The carbonyl 180° -pulse denoted by BS compensates for the Bloch-Siegert phase shift caused by the preceding pulse. The striped carbon pulses are off-resonance.

The sequence starts with proton magnetization that is labeled by the ^1H -chemical shift labeled during the t_1 -evolution period. Subsequently the magnetization is transferred to the attached carbons through a heteronuclear cross polarization of 6 ms. Simultaneously the magnetization transfer between the coupled carbon nuclei through homonuclear mixing begins. Its total length is preset in the pulse program to 12 ms. This is followed by the delay 2β in order to relay magnetization to the alpha-carbons. During the long delay 2ζ the C^α -coherence is relayed further to the carbonyl-carbons and at the same time defocusing with respect to the amide- ^{15}N takes place. The magnetization is converted to a ^{15}N -coherence by the first ^{15}N - 90° pulse and labeled by the nitrogen chemical shift in a constant time fashion. Finally the magnetization is refocused to an amide proton coherence for detection.

Sample: 2 mM ^{15}N , ^{13}C -labeled Ribonuclease T1, (104 a.a.).

Experiment time: 22h

Table 22: Acquisition Parameters

Parameter	Value	Comments
PULPROG	hcccconhgp3d1	pulse program
NUC1	^1H	nucleus on f1 channel
O1P	4.7 ppm	offset ^1H (or 3.0 ppm, see note below)
NUC2	^{13}C	nucleus on f2 channel
O2P	39 ppm	offset ^{13}C (centered on aliphatic ^{13}C region)
NUC3	^{15}N	nucleus on f3 channel
O3P	116 ppm	offset ^{15}N
PL0	120 dB	power level preceding shaped pulse f2
PL1		high power level f1 channel (^1H)
PL2	120 dB	high power level f2 channel (not used)
PL3		high power level f3 channel (^{15}N)
PL10		low power level for cross-polarization (^1H)
PL15		low power level for cross-polarization (^{13}C)
PL16		power level for GARP dec. f3 channel (^{15}N)
PL19		power level for DIPSI-2 decoupling f1 (^1H)
SP2		power level, 90° shaped pulse (^{13}C on res.)
SP3		power level, 180° shaped pulse (^{13}C on res.)
SP5	=sp3	power level, 180° shaped pulse (C' off res.)
SP7	=sp3	power level, 180° shaped pulse (C^α off res.)
SP8	=sp2	power level, time reversed 90° (^{13}C on res.)
SP9		power level, very selective 180° (C^α on res.)
SPNAM2	Q5.256	90° shape: 4 Gaussian cascade
SPNAM3	Q3.256	180° shape: 3 Gaussian cascade
SPNAM5	Q3.256	180° shape: 3 Gaussian cascade
SPNAM7	Q3.256	180° shape: 3 Gaussian cascade
SPNAM8	Q5tr.256	90° shape: time reversed 4 Gaussian casc.
SPNAM9	Q3.256	180° shape: 3 Gaussian cascade
SPOFF2,3,89	0 preset	
SPOFF5	preset	(^{13}C) in Hz (176-39 ppm)
SPOFF7	preset	(^{13}C) in Hz (54-176 ppm)
CNST21	176	carbonyl frequency
CNST22	54	alpha-carbon frequency

HCCH-TOCSY

Parameter	Value	Comments
CNST23	39	aliphatic carbon frequency
P1		90° ¹ H pulse f1 channel
P2		180° ¹ H pulse f1 channel
P6	25-28u	90° ¹ H cross-polarization pulse f1 channel
P9	preset to =p6	90° ¹³ C cross-polarization pulse f2 channel
P13	320u	90° selective pulse f2
P14	256u	180° selective pulse f2 channel
P16	1000u	gradient pulse length
P21		90° ¹⁵ N pulse f3 channel
P22		180° ¹⁵ N pulse f3 channel
P24	360u	180° very selective pulse f2 channel
PCDP1		decoupling pulse length DIPSI-2 channel f1
CPDPRG1	dipsi2	decoupling program channel f1 (¹ H)
PCDP3		decoupling pulse length GARP channel f3
CPDPRG3	garp	decoupling program channel f3 (¹³ C)
D1	1.5 s	recycle delay
D16	100u	gradient recovery
GPZ1	50	#1 gradient amplitude
GPZ2	8-30	#2 gradient amplitude
GPZ3	80	#3 gradient amplitude
GPZ4	8.1	#4 gradient amplitude
GPNAM1...4	SINE.100	gradient shapes
NS	16	number of scans
DS	64	dummy scans (x*2*ns because of E/A)
F3 acquisition	*****	(leftmost column)
AQ_MOD	DQD	digital quadrature detection
TD	2048	number of points
SW	14 ppm	sweep width
NUCLEI	¹ H	
F2 indirect ¹⁵N	*****	(middle column)
FnMODE	echo-antiecho	XWIN-NMR 3.0 and onwards
TD	40	number of real points
SW	35 ppm	sweep width indirect ¹⁵ N
ND10	2	no of in10 in pulse program
NUCLEI	¹⁵ N	
IN30	= IN10	Constant time decrement
F1 indirect ¹H	*****	(rightmost column)

Parameter	Value	Comments
FnMODE	States-TPPI	XWIN-NMR 3.0 and onwards
TD	160	number of real points
SW	7 ppm	sweep width indirect ¹ H; half of sw(F3)
ND0	2	no of in0 in pulse program
NUCLEI	¹ H	

Spectrum Processing

10.4

Table 23: Processing parameters

Parameter	Value	Comment
F3 acquisition		<i>(leftmost column)</i>
SI	2k	zero fill to 4096 complex points
WDW	QSINE	squared sine bell window function, e.g.
SSB	3	shifting of the sine bell, $\pi/3=60^\circ$
PH_mod	pk	phase correction applied
PHC0		zero order phase correction
PHC1		first order phase correction
BC_mod	qpol	water deconvolution
BCFW	1.0	range for water deconvolution
STSR	0	display only the left half of spectrum
STSI	1k	-, -
F2 indirect ¹⁵N	*****	<i>(middle column)</i>
SI	512	zero fill
MC2	echo-antiecho	
WDW	QSINE	squared sine bell window function
SSB	3	shifting of the sine bell, $\pi/3=60^\circ$
PH_MOD	no	no phase correction is needed
REVERSE	true	
F1 indirect ¹H	*****	<i>(rightmost column)</i>
SI	1k	zero fill
MC2	States-TPPI	
WDW	QSINE	squared sine bell window function
SSB	3	shifting of the sine bell, $\pi/3=60^\circ$
PH_mod	no	no phase correction is needed
SR	$\frac{1}{4}$ sw(F1)	set to $\frac{1}{4}$ of sw(F1) to correct scale

Fig. 39. The ^1H - ^1H and ^1H - ^{15}N planes of the H(CC)(CO)NH spectrum.

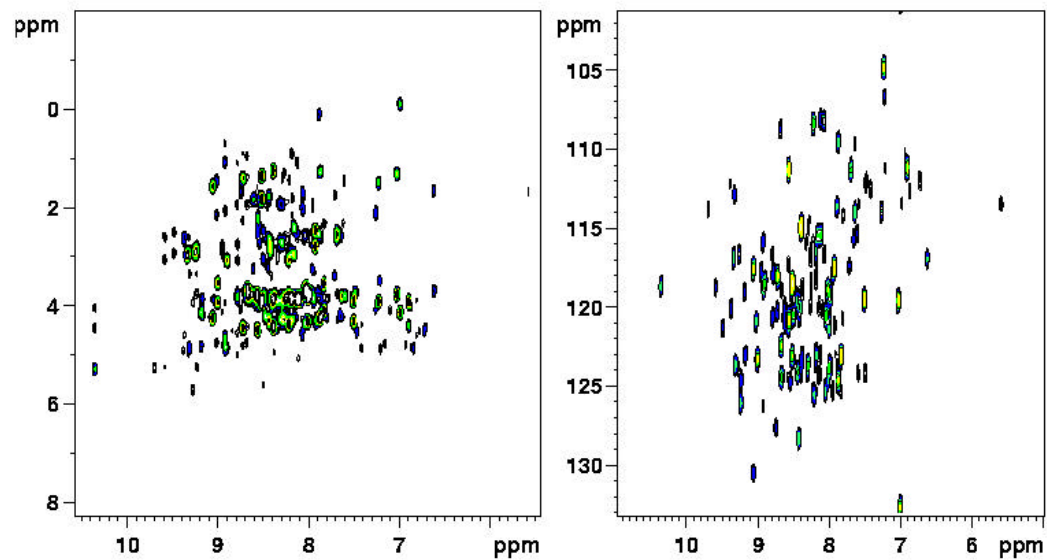

HCCH-TOCSY

11

Introduction

11.1

The HCCH-TOCSY experiment renders the ^1H - ^1H correlations within a spin system (the side chain protons of each residue in a polypeptide, e. g.) while separating the signals in the third dimension according to the ^{13}C frequency. Note however, that here the TOCSY-transfer is accomplished through a ^{13}C - ^{13}C mixing, instead of ^1H - ^1H mixing as in the 2D TOCSY experiment. For slowly tumbling macromolecules the 2D homonuclear experiment has lower sensitivity because, first, the natural ^1H linewidth ($=1/\pi T_2$) becomes larger than the ^1H - ^1H couplings and, second, ^{13}C labeling reduces the proton transverse relaxation time T_2 . The HCCH-TOCSY experiment relies on the strong one-bond ^1H - ^{13}C (125-250Hz) and ^{13}C - ^{13}C (35-55Hz) couplings for the magnetization transfer. The flow of the magnetization is as follows



A complementary experiment to HCCH-TOCSY is the HCCH-COSY experiment, which is based on transfer over one ^{13}C - ^{13}C bond and correlates neighbouring ^1H frequencies only. Both experiments are performed on ^{13}C -enriched samples. Thus, for protein studies, the HCCH-TOCSY and HCCH-COSY experiments are chosen to obtain side chain ^1H and ^{13}C assignments. To monitor through-space connectivities within and between side chains a three dimensional ^{13}C -correlated NOESY experiment can be recorded. Concerning the spectral analysis, the three experiments yield data in a similar format, which however, differs from that of the triple resonance experiments which separate the signals according to the backbone amide frequencies.

References:

A gradient-enhanced HCCH-TOCSY experiment for recording sidechain ^1H and ^{13}C correlations in H_2O samples of proteins. L. E. Kay, G.-Y. Xu, A. U. Singer, D. R. Muhandiram, J. D. Forman-Kay. JMR 101 B (1993) 333-337.

^1H - ^1H correlation via isotropic mixing of ^{13}C magnetization, a new three-dimensional approach for assigning ^1H and ^{13}C spectra of ^{13}C -enriched proteins. A. Bax, M. Clore, A. M. Gronenborn. J. Magn. Res. 88 (1990) 425-431.

Pulse Sequence Diagram

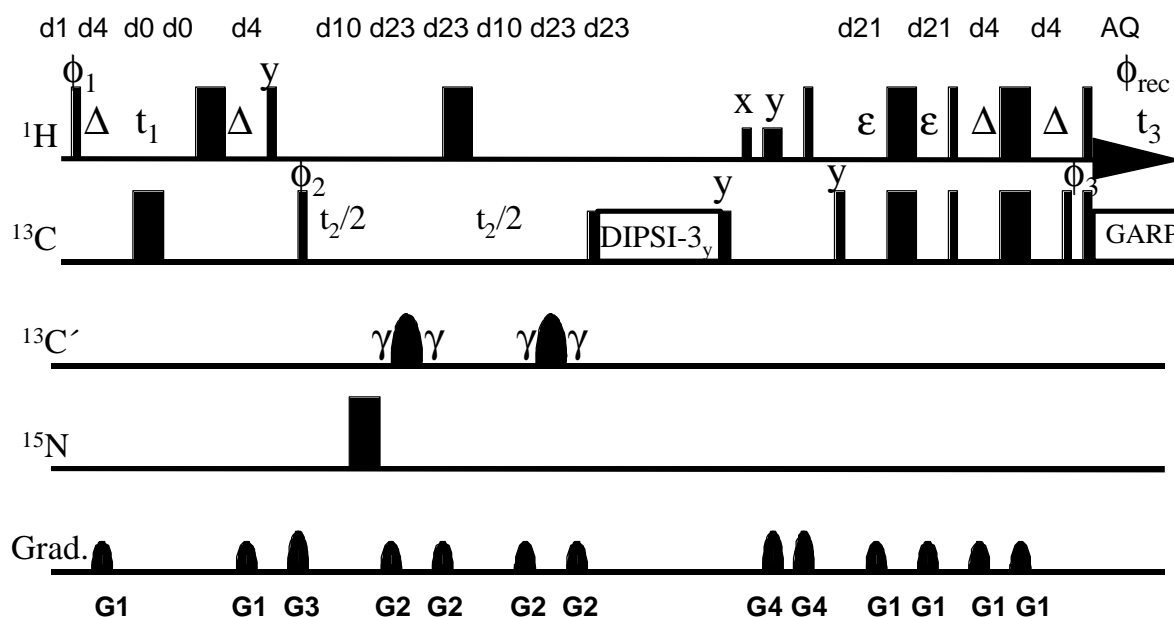

$$\begin{aligned} \phi_1 &= x, -x + \text{States-TPPI} (t_1) & \phi_2 &= 2(x), 2(-x) + \text{States-TPPI} (t_2) & \phi_3 &= 4(x), 4(-x) \\ \phi_{\text{rec}} &= x, -x, -x, x & \Delta &= 1/(4 \cdot J_{\text{HC}}) & \varepsilon &= 1/(6 \cdot J_{\text{HC}}) & 2 \cdot \gamma &= 1/(6 \cdot J_{\text{HC}}) \end{aligned}$$

Fig. 40. HCCH-TOCSY.

In the above diagram 90°-pulses are denoted by thin bars and 180°-pulses are denoted by thick bars. At the carbonyl frequency (¹³C') two 180° shaped pulses are applied. The pulse phases are x if not specified.

The pulse sequence starts with proton magnetization. After the ¹H-evolution time t_1 , the magnetization is transferred to the carbon-nuclei through the INEPT scheme. The antiphase ¹³C-magnetization is refocused during the intervals $2 \cdot \gamma$ (the length of which is a compromise for the different multiplicities), and labeled by the ¹³C-chemical shift during the t_2 -evolution time. The selective 180° pulses at the carbonyl frequency are applied in order to refocus C^α-C' coupling. The trim pulses at the beginning and the end of the mixing defocus all in-phase ¹³C-magnetization that is not parallel to the effective field.

The length of the isotropic mixing is regulated by the loop parameter l1. Assuming a ¹³C-mixing pulse of 25us, the l1-value of 1 gives a mixing time of 5.4ms (resulting in transfer over one bond), 2 gives 10.9 ms (transfer up to two bonds), 3 gives 16.3 ms (transfer up to three or more bonds). Finally, a reverse INEPT sequence brings the carbon magnetization back to the attached protons for detection. Water suppression is achieved by two z-filters and a pair of proton spin lock pulses.

Sample: 2 mM ^{15}N , ^{13}C -labeled Ribonuclease T1, (104 a.a.).

Experiment time: 16h

Table 24: Acquisition Parameters

Parameter	Value	Comments
PULPROG	hcchdigp3d	pulse program
NUC1	1H	nucleus on f1 channel
O1P	4.7 ppm	offset ^1H (optimized with „gs“)
NUC2	^{13}C	nucleus on f2 channel
O2P	39 ppm	offset ^{13}C
NUC3	^{15}N	nucleus on f3 channel
O3P	116 ppm	offset ^{15}N
PL0	120 dB	power level preceding shaped pulse
PL1		^1H high power level f1 channel
PL2		^{13}C high power level f2 channel
PL3		^{15}N high power level f3 channel
PL12		power level GARP decoupling f2
PL15		power level C-C cross polarization f2
SP5		180° off-resonance shaped pulse for carbonyl decoupling (C')
SPNAM5	Q3.256	shape: Gaussian cascade
SPOFF5	preset	= 130 ppm (^{13}C) in Hz(=176-39 ppm)
CNST21	176	carbonyl carbon frequency
P1		90° ^1H pulse f1 channel
P2	set to 2*p1	180° ^1H pulse f1 channel
P3		90° ^{13}C pulse f2 channel
P4	set to 2*p3	180° ^{13}C pulse f2 channel
P9	25u	low power pulse (cross polarization)
P14	256u	180° off-resonance shaped pulse for carbonyl decoupling (C')
P28	1m	^1H trim pulse for water suppression
P22		180° ^{15}N pulse f3 channel
PCDP2		decoupling pulse on ^{13}C f2
CPDPRG2	garp	decoupling program on ^{13}C f2
D1	1.5 s	recycle delay
D4	preset 1.6m	= $1/4$ (J_{CH})

HCCH-TOCSY

Parameter	Value	Comments
D21	preset 1.1m	= 1/6 (J_{CH})
D23	preset 475u	2*d23~ 1/6 (J_{CH})
D16	100u	gradient recovery
P16	preset 500u	length of #1 gradient
P19	preset 2m	length of #2 gradient
P29	preset 300u	length of #3 gradient
P30	preset 5m	length of #4 gradient
P31	preset 4.4m	length of second #4 gradient
GPZ1	16	#1 gradient amplitude
GPZ2	16	#2 gradient amplitude
GPZ3	30	#3 gradient amplitude
GPZ4	60	#4 gradient amplitude
GPNAM1	SINE.100	#1 gradient shape
GPNAM2	SINE.50	#2 gradient shape
GPNAM3	SINE.100	#3 gradient shape
GPNAM4	SINE.100	#3 gradient shape
NS	4	number of scans
DS	128	number of dummy scans
l1	1, 2 or 3	DIPSI mixing time, see text. MAX 3!
F3 1H acquisition	*****	(leftmost column)
AQ_MOD	DQD	digital quadrature detection
TD	2048	number of points
SW	8 ppm	sweep width, half of sw(F3)
NUCLEI	1H	
F2 indirect ^{13}C	*****	(middle column)
FnMODE	States-TPPI	XWIN-NMR 3.0 and onwards
TD	64	number of real points
SW	75 ppm	sweep width indirect ^{13}C
ND10	2	no of in10 in pulse program
NUCLEI	^{13}C	
F1 indirect 1H	*****	(rightmost column)
FnMODE	States-TPPI	XWIN-NMR 3.0 and onwards
TD	128	number of real points
SW	14 ppm	sweep width indirect 1H
ND0	2	no of in0 in pulse program
NUCLEI	1H	

Spectrum Processing

11.4

Table 25: Processing parameters

Parameter	Value	Comment
F3 acquisition	*****	(leftmost column)
SI	4k	zero fill
WDW	QSINE	squared sine bell
SSB	3	60° shifted
PH_mod	pk	phase correction applied
PHC0		zero order phase correction
PHC1		first order phase correction
BC_mod	no	no automatic baseline correction
F2 indirect ¹³C	*****	(middle column)
SI	256	zero fill
MC2	States-TPPI	
WDW	QSINE	squared sine bell
SSB	3	60° shifted
PH_mod	pk	phase correction
PHC0		zero order phase correction
PHC1		first order phase correction
BC_mod	no	no automatic baseline correction
F1 indirect ¹H	*****	(rightmost column)
SI	1k	zero fill
MC2	States-TPPI	
WDW	QSINE	squared sine bell
SSB	3	60° shifted
PH_mod	no	phase correction
BC_mod	no	no automatic baseline correction
SR	¼ of swH(F1)	For correct ppm scale

Fig. 41. The ^1H - ^1H (I1=3) and ^1H - ^{13}C planes of the HCCH-TOCSY spectrum.

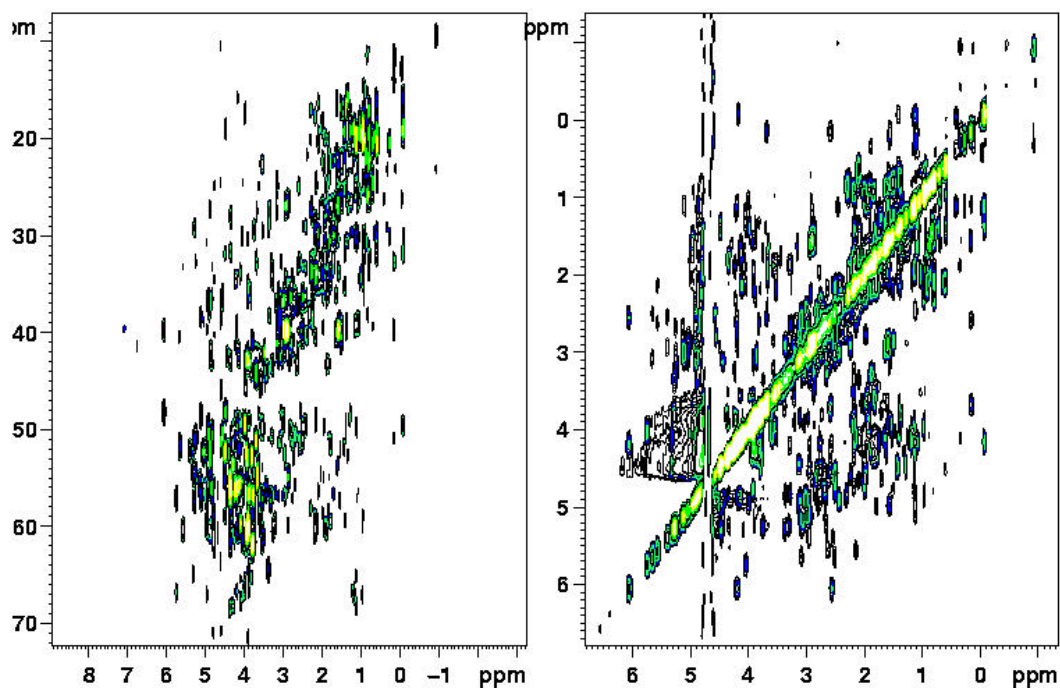

The ^1H - ^1H (I1=2) and ^1H - ^1H (I1=1) planes of the HCCH-TOCSY spectrum.

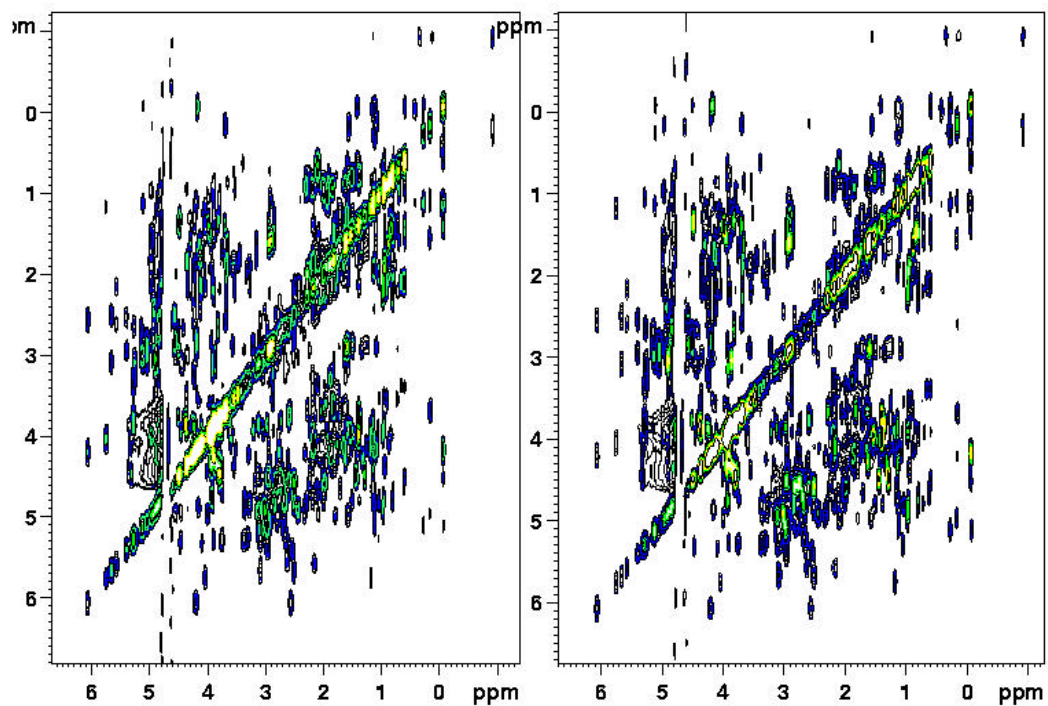

Appendices

12

Coupling constants in polypeptides

12.1

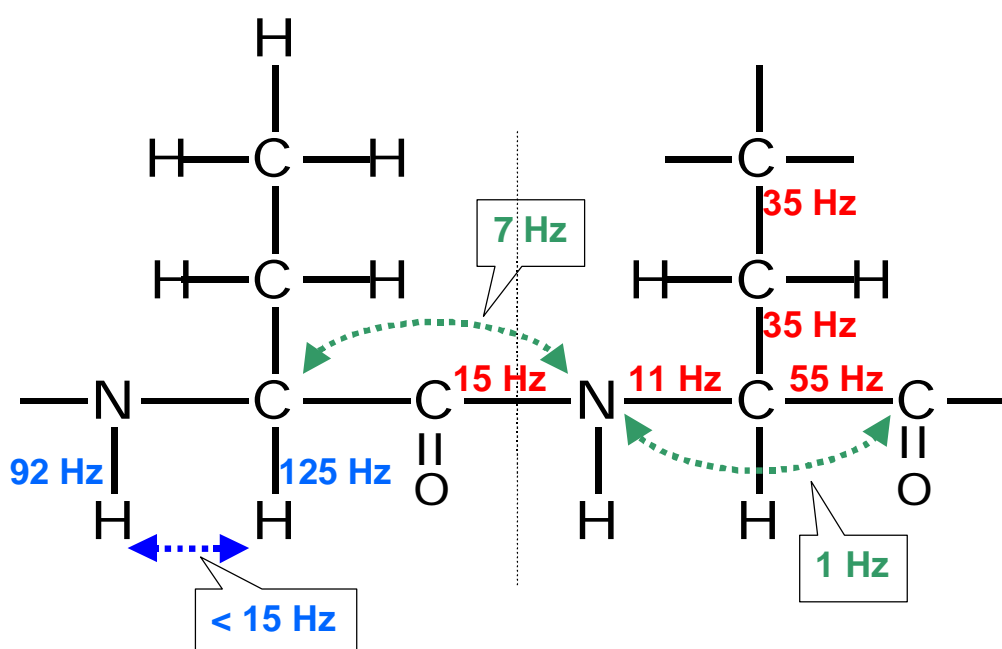

Fig. 42. One-bond and two-bond coupling constants in the polypeptide backbone.

The coupling constants used for magnetization transfer in the most common experiments are indicated above. On the left coupling constants involving protons are shown and on the right the ones involving heteronuclei. Note that the one-bond J_{CH} in aromatic rings is around 160 Hz. Usually a compromise value of 135 Hz is used. The dashed lines and corresponding framed values indicate some relevant coupling constants over two bonds.

Reference:

Heteronuclear multidimensional NMR experiments for the structure determination of proteins in solution employing pulsed field gradients. M. Sattler, J. Schleucher & C. Griesinger. Prog. in NMR Spectroscopy 34 (1999) 93-158.

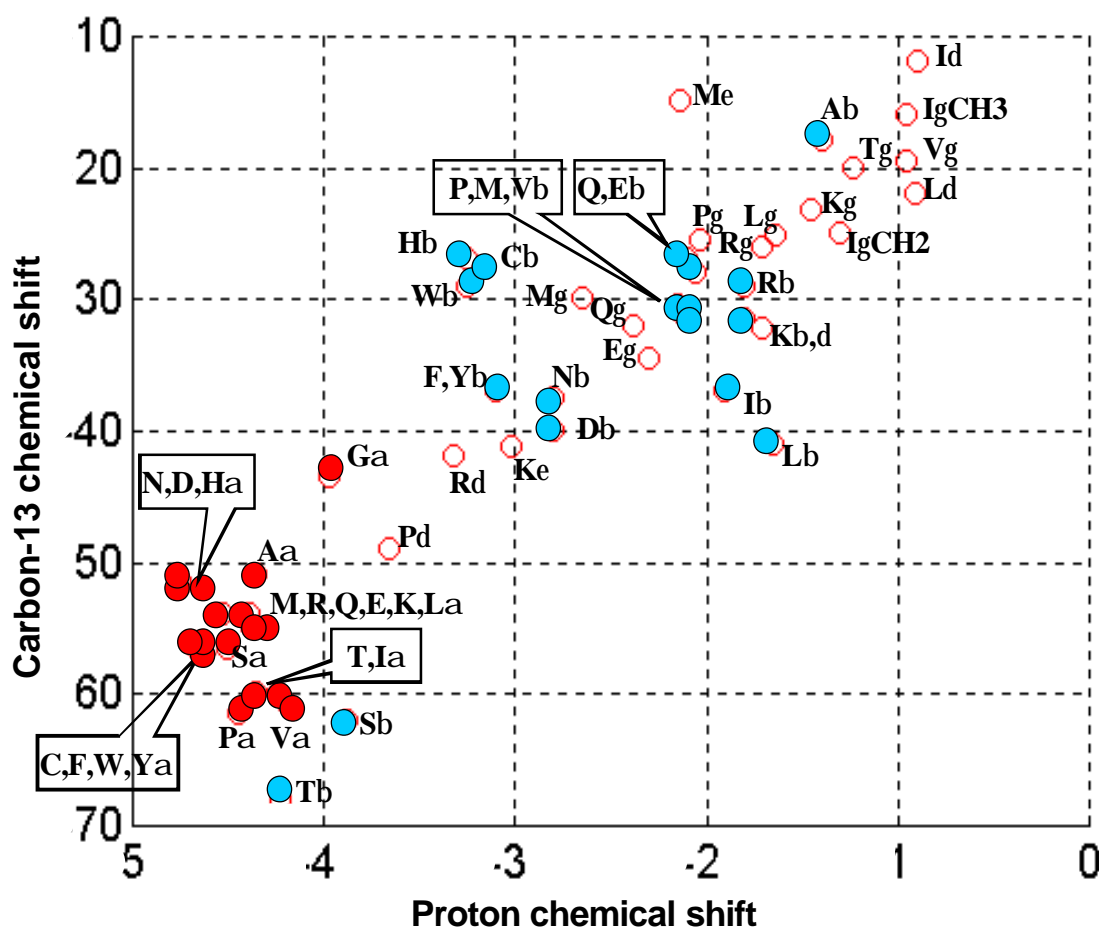

Fig. 43. The random coil ^1H and ^{13}C chemical shifts in the natural amino acids.

Compared to the above indicated aliphatic random coil values, the alpha-carbons shift approximately +3 ppm in α -helices and -2 ppm in β -sheets. The corresponding values for the beta-carbons are: -1 ppm in α -helices, +3 ppm in β -sheets. The alpha-carbon shifts about -2 ppm in any residue preceding a proline residue.

Above the values for a reduced cysteine are indicated, whereas in a disulfide bridged cysteine the alpha-carbon is found at 52.5 ppm and the beta-carbon 39.4 ppm. For the aspartic acid and glutamic acid values of the non-protonated sidechain carboxyl acid are reported. The values for the protonated form are 36 ppm for beta-carbon in aspartic acid and 32 ppm for gamma-carbon in glutamic acid. Proline in the trans-conformation has alpha-carbon at 63.2 ppm (in the cis-form 62.4 ppm) and beta-carbon at 31.1 ppm (the cis-form 33.1 ppm).

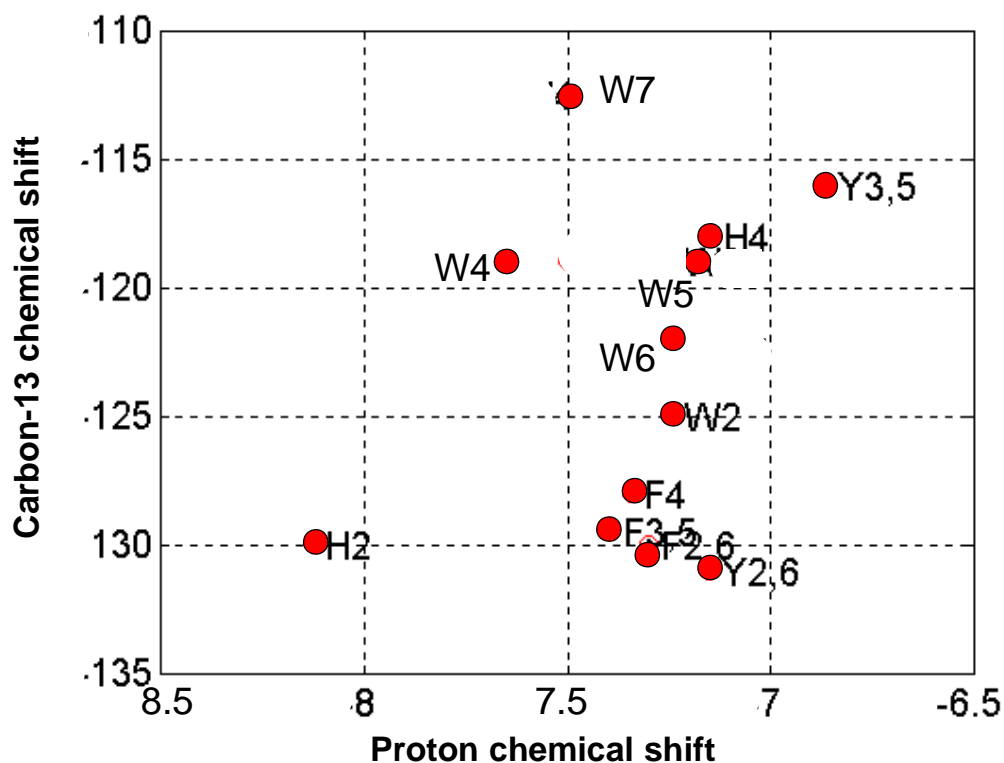

Fig. 44. The random coil ring ^1H and ^{13}C chemical shifts of histidine, tyrosine, phenylalanine and tryptophan.

Note: Tryptophan: W2= δ 1, W4= ϵ 3, W5= ζ 3, W6= η 2, W7= ζ 2

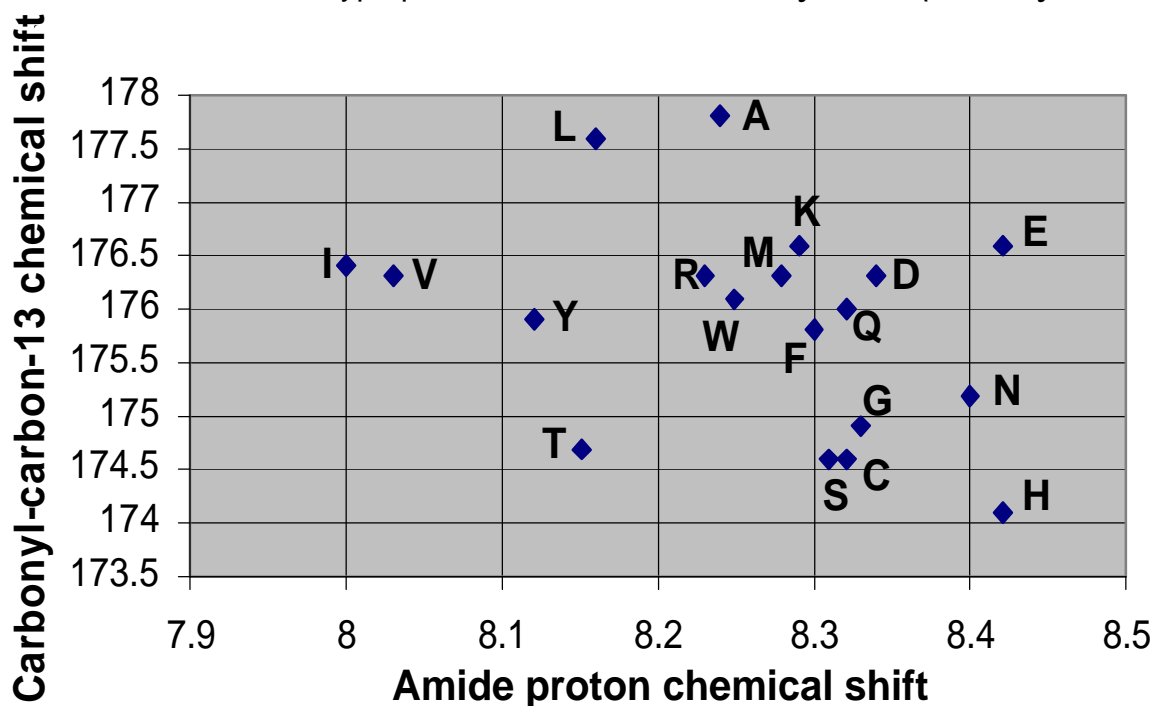

Fig. 45. The random coil amide ^1H and carbonyl ^{13}C chemical shifts in the natural amino acids.

Compared to the above indicated random coil values, the carbonyl- ^{13}C frequencies shift approximately +2 ppm in α -helices and -1 ppm in β -sheets.

References:

Carbon-13-NMR of Peptides and Proteins. O. W. Howarth & D. M. J. Lilley (1978) Prog. NMR Spectr. 12, 1-40.

NMR of proteins and nucleic acids. Wüthrich, K. (1986) Wiley, New York.

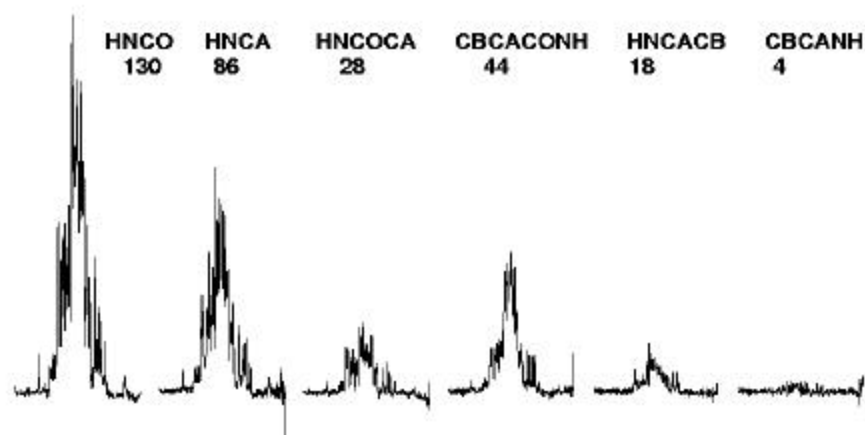
Sensitivity of triple resonance experiments**12.3**

Fig. 46. The first increment of some triple resonance experiments.

The sample is 2mM double-labeled ribonuclease T1, number of scans 8. The spectra were recorded on a CryoProbe system at 600MHz. The numbers indicate the signal to noise ratio for the largest peak. The HNCA is not comparable due to a very long first ^{13}C -increment.